

# HOTEL CATALOGUE 2021



Hospitality Excellence since 1928



# ABOUT US

**EN** As an industry pioneer since 1928, Caddie designs and manufactures innovative handling equipment for hotels. The asset that has driven our expansion and success is the customer-centric product development enabled by our in-house design office. This has allowed us to set up a reliable, durable and functional range of trolley for housekeeping, front office, conference as well as laundry and room service.

**FR** Depuis 1928, les solutions et le service orientés vers le client ont conduit le succès et l'expansion internationale de Caddie. C'est cette expérience qui nous permet aujourd'hui de vous proposer un porte-feuille complet de solutions fiables, durables et fonctionnelles pour la réception, les étages, le service banquet et conférence, la circulation du linge et la restauration en chambre.

**IT** In qualità di pioniere fra i fornitori dell'industria alberghiera, Caddie progetta e produce carrelli e attrezzature per Hotel dal 1928. Lo studio di soluzioni atte a soddisfare qualsiasi tipo di esigenza e il nostro servizio di progettazione e ricerca sono stati i punti chiave del nostro successo a livello internazionale. La nostra esperienza ci permette di offrirvi un ventaglio di prodotti affidabili, durevoli e funzionali per reception, servizio ai piani, servizio in camera, servizio biancheria, catering e conferenze.

**DE** Als Pionier der Branche entwickelt und produziert Caddie seit 1928 innovative Hotel-Transportlösungen. Ein entscheidender Erfolgsfaktor der letzten Jahre ist zweifelsohne die kundenorientierte Produktentwicklung durch eigene Produktdesigner. Dies hat es uns ermöglicht, ein zuverlässiges, langlebiges und funktionales Sortiment an Zimmermädchenwagen sowie Front Office, Konferenz, Wäsche- und Roomservicewagen aufzubauen.

**EN** Caddie Hotel subsidiaries and distributors are located in different countries, which are strategic hubs in the international market. The concept and design phase is developed by the Italian headquarters according to the customer needs.

**IT** Caddie Hotel si avvale di magazzini e distributori dislocati in diversi paesi, punti strategici nel mercato mondiale. La progettazione parte dalla sede centrale italiana che sviluppa le soluzioni più adatte alle esigenze del cliente e del mercato.

**FR** Notre usine principale basée en Italie conçoit et développe les solutions les plus adaptées aux besoins des clients et grâce à nos différentes filiales, nous avons renforcé notre présence à l'international.

**DE** Caddie Hotel ist an mehreren, für den Hotelmarkt strategisch wichtigen Standorten durch Tochterfirmen oder Distributoren vertreten. Unser Herz und der Entwicklungsstandort liegt in Italien. Hier entwickeln und designen wir unsere bedarfsorientierten Produkte.

## GLOBAL NETWORK





# PHILOSOPHY

**EN** Caddie always stood and still stands for reliability, durability and a strong affinity for design.

Since the commercial foundation of Caddie Hotel, those product and brand characteristics are complemented by a customer oriented sales and associated service concept, led by a dedicated team with a long history and expertise in the hotel market. Together we are constantly working on solutions that support our customers in dealing with their daily challenges.

**FR** Fiabilité, longévité et design séduisant caractérisent depuis toujours la marque Caddie.

La création de Caddie Hotel a permis un support commercial complètement orienté vers nos clients, avec une équipe expérimentée dans le domaine de l'hôtellerie. Ensemble, nous collaborons constamment à la mise en œuvre de solutions facilitant le quotidien opérationnel de nos clients.

**IT** Il marchio Caddie è sinonimo di prodotti affidabili e dal design accattivante. Inoltre, con la creazione di Caddie Hotel, abbiamo aggiunto alle qualità legate al prodotto anche un supporto commerciale completamente orientato al cliente, formato da un team dedicato e con esperienza nel mercato alberghiero. Insieme collaboriamo costantemente per la creazione di soluzioni che supportino i nostri clienti nell'affrontare le loro sfide quotidiane.

**DE** Caddie Hotel - der Name steht für Zuverlässigkeit, Langlebigkeit und eine hohe Design-Affinität. Ergänzt werden diese Markeneigenschaften seit der Neufirmierung der Caddie Hotel GmbH um einen kundennah ausgerichteten Vertrieb und vor allem um ein engagiertes Team mit langjähriger Erfahrung im Hotelbereich.

Gemeinsam arbeiten wir stets daran, unsere Kunden bei ihren täglichen Herausforderungen bestmöglich zu unterstützen.

FRONT OFFICE \_\_\_\_\_ 11

Transbag One IN \_\_\_\_\_ 12  
 Transbag One BR \_\_\_\_\_ 13  
 Transbag Vip CR / BR M / L \_\_\_\_\_ 14  
 Transbag Smart CR / BR M / L \_\_\_\_\_ 15  
 Transbag Eco IN / Cube \_\_\_\_\_ 16  
 Orsa IN / BR / Orsa Dakar \_\_\_\_\_ 17  
 Teseo IN / BR S / L \_\_\_\_\_ 18  
 Teseo CR Easy ST \_\_\_\_\_ 19  
 Ercole CR Easy \_\_\_\_\_ 19  
 Ercole BR / CR S / L \_\_\_\_\_ 20  
 Rollbag \_\_\_\_\_ 21  
 Masterinox 500 / Easy \_\_\_\_\_ 22  
 Roulstar Eco / Easy \_\_\_\_\_ 23  
 Colyse / Equinox 27 \_\_\_\_\_ 24  
 Volo / Volo GR \_\_\_\_\_ 25  
 Spiga / Cord \_\_\_\_\_ 26  
 Riga / Corda \_\_\_\_\_ 27  
 Retrax / Wall A & B \_\_\_\_\_ 28  
 Info / Display \_\_\_\_\_ 29

HOUSEKEEPING \_\_\_\_\_ 31

Bali \_\_\_\_\_ 32  
 The Caddie \_\_\_\_\_ 34  
 Palace \_\_\_\_\_ 36  
 Tahiti S / M / L \_\_\_\_\_ 38  
 Fidji S / M / L \_\_\_\_\_ 40  
 George S / M / L \_\_\_\_\_ 42  
 George XL \_\_\_\_\_ 44  
 Dakar Alu \_\_\_\_\_ 45  
 Palace Easy \_\_\_\_\_ 46  
 Capri / Capri Eco \_\_\_\_\_ 48  
 Halley 2 / 4 \_\_\_\_\_ 49  
 Palacenet \_\_\_\_\_ 50  
 Ibiza S / M / L \_\_\_\_\_ 51  
 Easy / Ponza \_\_\_\_\_ 52  
 Samoa S / M \_\_\_\_\_ 53  
 Ambiente / Transnet \_\_\_\_\_ 54  
 Plasnet \_\_\_\_\_ 55  
 Floor Safety Sign \_\_\_\_\_ 55

LAUNDRY SERVICE \_\_\_\_\_

Caddie Sac / Hydro \_\_\_\_\_  
 Caddie Sac XS / Hydro XS \_\_\_\_\_  
 Ibiza Trisac 2 / Caddie X \_\_\_\_\_  
 Caddie X Eco / Caddie X Easy \_\_\_\_\_  
 Trisac 1 / 2 / 3 \_\_\_\_\_  
 Trisac Alu 1 / 2 / 3 / 4 \_\_\_\_\_  
 Sirio / Sirio Ergo / Cesto \_\_\_\_\_  
 Bactainer Alu / Alu S/L \_\_\_\_\_  
 Bactainer 180 L / 360 L \_\_\_\_\_  
 Mobilinge \_\_\_\_\_  
 Mobilinge M / L \_\_\_\_\_  
 Translinge \_\_\_\_\_  
 Roll Linge Easy / Easy 3 / Flip Front \_\_\_\_\_  
 Roll Base / 3 / 4 \_\_\_\_\_  
 Roll Linge Security 10 / 250 \_\_\_\_\_  
 Roll Sicurezza 1 / 2 \_\_\_\_\_  
 Stender Z / Base Z \_\_\_\_\_  
 Stender Easy / Easy HR \_\_\_\_\_



# INDEX



_____ 57	ROOM SERVICE _____ 77	FOOD SERVICE _____ 103
_____ 58	The Caddie Bar _____ 78	Coffie / Tray Stand W _____ 104
_____ 59	B-Palace _____ 80	Ice Caddie / Plate Caddie _____ 105
_____ 60	Ibiza Bar M / L _____ 82	Caddinox 2 / 3 _____ 106
_____ 61	Bora Bora M / L _____ 83	Super Caddinox 2 / 3 _____ 107
_____ 62	Charlotte M / L _____ 84	Verso 12 / 12P _____ 108
_____ 63	Bali Bar _____ 85	Verso 24 / 24P _____ 109
_____ 64	Theliverie _____ 86	Alto 2 / 3 _____ 110
_____ 65	Table Easy _____ 87	Alto Flambè / 5PM _____ 111
_____ 66	Table Compact XS _____ 88	Alto Wine / Mixology _____ 112
_____ 67	Table Flip Top _____ 89	Alto Bolla / Ice 3 _____ 113
_____ 68	Hot Box _____ 90	Arte 2 / BM 1 _____ 114
_____ 69	Box Taxi _____ 91	Arte SP _____ 115
_____ 70	Table Flip Top Eco 80/90 _____ 92	Cuttie _____ 116
_____ 71	Hot Box Eco _____ 93	Hottie Air CR / BR / CP _____ 117
_____ 72	Box Taxi Eco _____ 94	Hottie 1H Fix BR / 2H Flex BR _____ 118
_____ 73	Passpartout 2 / 3 _____ 95	Hottie-P 1H Flex CR / 2H Fix CR _____ 119
_____ 74	Luggage Rack CR / S / BR / S _____ 96	Hottie Board G/ Board 60x40 _____ 120
_____ 75	Luggage rack W-MG / W-LNO / WS-LNO _____ 97	Hottie-P 2L / 3L _____ 121
	Gea / Verso R _____ 98	
	Lucy _____ 99	
	Foldie Eco _____ 100	
	Babybed Sleep'n Play _____ 101	
	Beddie _____ 101	



EN	IT	FR	DE	
CASTORS	RUOTE	ROULETTES	ROLLEN	122
OPTIONS	OPTIONALS	OPTIONS	OPTIONEN	124
PANEL FINISH	FINITURE	FINITIONS	DEKORE	133



# FRONT OFFICE

**EN One of our areas of expertise:** for the secure and stylish transportation of suitcases and bags, Caddie Hotel offers a broad range of luggage carts that will fit perfectly in your hotel's interior.

**IT Una delle nostre aree di competenza:** per un trasporto elegante e sicuro dei bagagli, Caddie Hotel propone un'ampia gamma di carrelli il cui aspetto si accosta perfettamente allo stile del vostro hotel.

**FR L'un de nos secteurs d'expertise:** pour le transport élégant et sûr de bagages, Caddie Hotel propose une large gamme de chariots dont la finition et l'aspect s'inscriront parfaitement dans la décoration intérieure de votre établissement.

**DE Eines unserer Spezialgebiete:** für den sicheren und stilvollen Transport von Koffern und Taschen bietet Caddie Hotel ein großes Sortiment an Gepäckwagen, das sich optimal in das Gesamtkonzept Ihres Hotels einfügt.



**THE ONE  
AND ONLY**



- EN** • Highly shock-absorbent, non-marking and full wrap-around rubber bumper in anthracite color, interchangeable
- Hanging rail for coat hangers (48 cm)
  - Thick and soft velour carpet made of 100% Polyamide

- IT** • Bordo paracolpo in gomma colore antracite antiurto, antitraccia, intercambiabile
- Barra appendiabiti (48 cm)
  - Moquette spessa e soffice in poliammide 100%

- FR** • Pare-chocs intégral souple en caoutchouc non-marquant, coloris anthracite, remplaçable
- Barre penderie pour cintres (48 cm)
  - Moquette épaisse et souple 100% polyamide

- DE** • Extrem stoßdämpfender, nicht abfärbender rundum Gummistoßschutz in anthrazit, auswechselbar
- Kleiderstange (48 cm) für Kleiderbügel
  - Velour-Teppich aus 100% Polyamid

**Options****Available colours**

 Grey | Grigio | Gris | Grau  Blue | Blu | Bleu | Blau

 Red | Rosso | Rouge | Rot  Black | Nero | Noir | Schwarz

							
<b>TRANSBAG ONE IN</b>	max. 300 Kg	2 swivel and 2 fixed Ø 200 mm 'RG'	Matt stainless steel tube Ø50mm Acciaio inox spazzolato Ø50mm Tubes acier inoxydable brossé Ø50mm Edelstahlrohr matt Ø50mm	1120x 650x h1920 mm	9 - 12	60 Kg	997290IN



## TRANSBAG ONE BR



THE ONE  
AND ONLY

- EN**
- Highly shock-absorbent, non-marking and full wrap-around rubber bumper in anthracite color, interchangeable
  - Hanging rail for coat hangers (48 cm)
  - Thick and soft velour carpet made of 100% Polyamide

- FR**
- Pare-chocs intégral souple en caoutchouc non-marquant, coloris anthracite, remplaçable
  - Barre penderie pour cintres (48 cm)
  - Moquette épaisse et souple 100% polyamide

- IT**
- Bordo paracolpo in gomma colore antracite antiurto, antitraccia, intercambiabile
  - Barra appendiabiti (48 cm)
  - Moquette spessa e soffice in poliammide 100%

- DE**
- Extrem stoßdämpfender, nicht abfärbender rundum Gummistoßschutz in anthrazit, auswechselbar
  - Kleiderstange (48 cm) für Kleiderbügel
  - Velour-Teppich aus 100% Polyamid

### Options

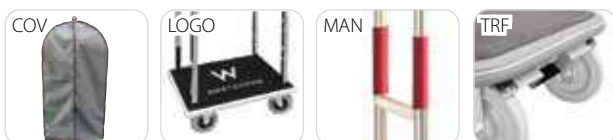

### Available colours



Grey | Grigio | Gris | Grau



Blue | Blu | Bleu | Blau



Red | Rosso | Rouge | Rot



Black | Nero | Noir | Schwarz

<b>TRANSBAG ONE BR</b>	max. 300 Kg	2 swivel and 2 fixed Ø 200 mm 'RG'	Brass plated steel tube Ø50 mm Tubo in acciaio ottonato Ø50 mm Tubes en acier plaqué laiton Ø50 mm Messingrohr massiv Ø50 mm	1120x 650x h1920 mm	9 - 12	60 Kg	99720909

## TRANSBAG VIP CR M / L

## TRANSBAG VIP BR M / L



TRANSBAG VIP CR L



TRANSBAG VIP BR L

- EN**
- Non-marking and full wrap-around rubber bumper in light grey
  - Hanging rail for coat hangers (48 cm)
  - Thick and soft velour carpet made of 100% polyamide

- FR**
- Pare-chocs intégral en caoutchouc non-marquant gris
  - Barre penderie pour cintres (48 cm)
  - Moquette épaisse et souple 100% polyamide



- IT**
- Bordo paracolpo in gomma antitraccia colore grigio chiaro.
  - Barra appendiabiti (48 cm)
  - Moquette spessa e soffice in poliammide 100%

- DE**
- Nicht abfärbender rundum Gummistoßschutz in hellgrau
  - Kleiderstange (48 cm) für Kleiderbügel
  - Velour-Teppich aus 100% Polyamid







## Options



## Available colours

 Grey | Grigio | Gris | Grau  Blue | Blu | Bleu | Blau

 Red | Rosso | Rouge | Rot  Black | Nero | Noir | Schwarz

							
<b>TRANSBAG VIP CR M</b>	max. 300 Kg	2 swivel and 2 fixed Ø 200 mm 'RG'	Steel tube with chrome finish Ø 40 mm	935x 645x h1997 mm	8 - 10	41 Kg	010001CR
<b>TRANSBAG VIP CR L</b>			Tubo in acciaio cromato Ø40 mm	1130x 650x h1997 mm	9 - 12	45 Kg	010002CR
<b>TRANSBAG VIP BR M</b>	max. 300 Kg	2 swivel and 2 fixed Ø 200 mm 'RG'	Brass plated steel tube Ø40 mm	935x 645x h1997 mm	8 - 10	41 Kg	010001BR
<b>TRANSBAG VIP BR L</b>			Tubo in acciaio ottonato Ø40 mm	1130x 650x h1997 mm	9 - 12	45 Kg	010002BR

## TRANSBAG SMART CR M / L

## TRANSBAG SMART BR M / L



TRANSBAG SMART CR L



TRANSBAG SMART BR L

- EN** • Non-marking and full wrap-around rubber bumper in light grey  
 • Hanging rail for coat hangers (48 cm)  
 • Durable carpet made of 100% Polypropylene

- IT** • Bordo paracolpo in gomma antitraccia colore grigio chiaro  
 • Barra (48 cm) per appendere i cappotti  
 • Moquette di lunga durata in polipropilene 100%

- FR** • Pare-chocs intégral en caoutchouc gris clair  
 • Barre penderie pour cintres (48 cm)  
 • Moquette très résistante 100% polypropylène

- DE** • Nicht abfärbender rundum Gummistoßschutz in hellgrau  
 • Kleiderstange (48 cm) für Kleiderbügel  
 • Strapazierfähiger Teppich aus 100% Polypropylen

### Options

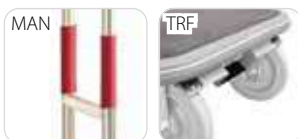

### Available colours

- Grey | Grigio | Gris | Grau
  Blue | Blu | Bleu | Blau
- Red | Rosso | Rouge | Rot
  Black | Nero | Noir | Schwarz

<b>TRANSBAG SMART CR M</b>	max. 300 Kg	2 swivel and 2 fixed Ø 200 mm 'RG'	Steel tube with chrome finish Ø40mm Tubo in acciaio cromato Ø40 mm	891x 645x h1910 mm	8 - 10	40 Kg	CAD00050
<b>TRANSBAG SMART CR L</b>			Tubes acier chromé Ø40mm Stahlrohr verchromt Ø40 mm	1091x 650x h1910 mm	9 - 12	44 Kg	CAD00048
<b>TRANSBAG SMART BR M</b>	max. 300 Kg		Brass plated steel tube Ø40 mm Tubo in acciaio ottonato Ø40 mm	891x 645x h1910 mm	8 - 10	40 Kg	CAD00055
<b>TRANSBAG SMART BR L</b>			Tubes en acier plaqué laiton Ø40 mm Messingrohr massiv Ø40 mm	1091x 650x h1910 mm	9 - 12	44 Kg	CAD00056



## TRANSBAG ECO IN

NEW



## CUBE



- EN** • Non-marking and full wrap-around rubber bumper  
• Hanging rail for coat hangers  
• Dark grey carpet  
• 2 swivel castors with brake and 2 fixed

- IT** • Bordo paracolpo in gomma antiurto, antitraccia  
• Barra appendiabiti  
• Moquette grigia scura  
• 2 ruote girevoli con freno e 2 ruote fisse

- FR** • Pare-chocs intégral en caoutchouc non-marquant  
• Barre penderie pour cintres  
• Moquette gris foncé  
• 2 roues pivotantes avec frein et 2 fixes

- DE** • Extrem stoßdämpfender, nicht abfärbender rundum Gummistoßschutz  
• Kleiderstange für Kleiderbügel  
• Elour-Teppich dunkelgrau  
• 2 Bockrollen, davon 2 Lenk-Bremsrollen

- EN** • Non-marking and full wrap-around rubber bumper in light grey  
• Hanging rail (48 cm) for coat hangers  
• Thick and soft velour carpet in 100% polyamide

- IT** • Bordo paracolpo in gomma antitraccia grigio chiaro  
• Barra appendiabiti (48 cm)  
• Moquette spessa e soffice in poliammide 100%

- FR** • Pare-chocs intégral en caoutchouc gris clair  
• Barre penderie pour cintres (48 cm)  
• Moquette épaisse 100% polyamide

- DE** • Nicht abfärbender rundum Gummistoßschutz in hellgrau  
• Kleiderstange (48 cm) für Kleiderbügel  
• Velour-Teppich aus 100% Samt-Polyamid.

## Options

Options only available for the products marked with '\* \*'  
Optional disponibile solo per i prodotti segnati con '\* \*'  
Options seulement disponibles pour les produits désignés par '\* \*'  
Optionen nur für die mit \* markierten Modelle

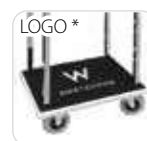

## Available colours for CUBE



Grey | Grigio | Gris | Grau



Blue | Blu | Bleu | Blau



Red | Rosso | Rouge | Rot



Black | Nero | Noir | Schwarz

							
<b>TRANSBAG ECO IN</b>	max. 300 Kg	2 swivel and 2 fixed x Ø150 mm	Brushed stainless steel tube Ø50mm Acciaio inox spazzolato Ø50mm Tubes acier inoxydable brossé 50mm Edelstahlrohr matt Ø50mm	1090x 650x h1960 mm	9 - 12	43,5 Kg	CAD00127 
<b>CUBE *</b>		2 swivel and 2 fixed Ø 200 mm 'RG'	Chromed square steel tube Struttura quadrata in acciaio cromato Tubes carré acier chromé Vierkantstahlrohr verchromt	905x 595x h1860 mm	8 - 10	48 Kg	010100CR



## ORSA IN / BR



## ORSA DAKAR



- EN**
- Space-saving foldable when not in use
  - Sheathed handle (with plastic grip)
  - Durable carpet made of 100% Polypropylene

- IT**
- Pieghevole quando non in uso
  - Impugnatura in plastica
  - Moquette di lunga durata in polipropilene 100%

- FR**
- Plateforme repliable et rails de pose avec protection
  - Poignée gainée
  - Moquette très résistante 100% polypropylène

- DE**
- Platzsparend zusammenklappbar bei Nichtgebrauch
  - Ummantelter Handgriff
  - Strapazierfähiger Teppich aus 100% Polypropylen

- EN**
- Completely foldable, space-saving storage when not in use
  - Sheathed handle (with plastic grip)
  - Durable carpet made of 100% Polypropylene

- IT**
- Completamente pieghevole quando non in uso
  - Impugnatura in plastica
  - Moquette di lunga durata in polipropilene 100%

- FR**
- Plateforme repliable et rails de pose avec protection
  - Poignée gainée
  - Moquette très résistante 100% polypropylène

- DE**
- Platzsparend zusammenklappbar bei Nichtgebrauch
  - Ummantelter Handgriff
  - Strapazierfähiger Teppich aus 100% Polypropylen

## Available colours



Grey | Grigio | Gris | Grau



Blue | Blu | Bleu | Blau



Red | Rosso | Rouge | Rot



Black | Nero | Noir | Schwarz

	KG					KG	CODE
<b>ORSA BR</b>	max. 150 Kg	2 x Ø300 mm 'PNP'	Steel tube with brass finish Ø28 mm Acciaio ottonato Ø28 mm Acier laitonné Ø28 mm Stahlrohr vermessingt Ø28 mm	1052 (open)/ 409 (closed)x 573x h1217	6 - 7	30 Kg	010500BR
<b>ORSA IN</b>			Stainless steel Ø28 mm Acciaio inox Ø28 mm Acier inoxydable Ø28 mm Edelstahlrohr gebürstet Ø28 mm				010500IN
<b>ORSA DAKAR</b>		2 pneumatic x Ø260 mm 'TT'		1080 (open)/411x 625 (close)x h1101 mm			010501IN

TESEO IN S / L

TESEO BR S / L



TESEO IN L



TESEO BR S

- EN** • Non marking and full wrap-around rubber bumper  
• Durable carpet made of 100% polypropylene

- IT** • Bordo paracolpo in gomma antitraccia  
• Moquette di lunga durata in polipropilene 100%

- FR** • Pare-chocs intégral en caoutchouc gris non-marquant  
• Moquette très résistante 100% polypropylène

- DE** • Nicht abfärbender rundum Gummistoßschutz  
• Strapazierfähiger Teppich aus 100% Polypropylen

Available colours

- Grey | Grigio | Gris | Grau
- Blue | Blu | Bleu | Blau
- Red | Rosso | Rouge | Rot
- Black | Nero | Noir | Schwarz

Options



<b>TESEO IN S</b>	max. 300 Kg	2 swivel and 2 fixed x Ø200 mm 'RG'	Stainless steel Ø28 mm Tubo in acciaio inox Ø28 mm Tubes acier inoxydable Ø28 mm	891x 591x h1709 mm	7 - 9	40 Kg	010301IN
<b>TESEO IN L</b>			Edelstahlrohr Ø28 mm	1091x 591x h1709 mm	9 - 11	50 Kg	010302IN
<b>TESEO BR S</b>	max. 300 Kg		Brassed steel tube Ø28 mm Tubo in acciaio ottonato Ø28 mm	891x 591x h1709 mm	7 - 9	40 Kg	010301BR
<b>TESEO BR L</b>			Messingrohr massiv Ø28 mm	1091x 591x h1709 mm	9 - 11	50 Kg	010302BR

## TESEO CR EASY ST

NEW



TESEO CR EASY ST

- EN**
- Stainless steel sheet deck
  - Side pushing bars
  - Grey rubber bumper rings at corners
- IT**
- Base in lamiera in acciaio inox
  - Maniglioni di spinta
  - Angoli con paracolpi in gomma grigia
- FR**
- Base pleine in acier inoxydable
  - Poignée de poussée
  - Pare-chocs angulaires
- DE**
- Bodenplatte in Edelstahl
  - Schiebebügel
  - Seitliche Abweiseringe









## ERCOLE CR EASY

NEW



ERCOLE CR EASY

- EN**
- 4 rubber bumper rings at corners
  - Durable carpet made of 100% Polypropylene
  - Side pushing bars
- IT**
- Angoli con paracolpi in gomma grigia
  - Moquette di lunga durata in polipropilene 100%
  - Maniglioni di spinta
- FR**
- Pare-chocs angulaires
  - Moquette très résistante 100% polypropylène
  - Poignée de poussée
- DE**
- Seitliche Abweiseringe
  - Strapazierfähiger Teppich aus 100% Polypropylen
  - Schiebebügel

							
<b>TESEO CR EASY ST</b>	max. 150 Kg	4 swivel x Ø 140 mm	Stainless steel tube Tubo in acciaio inox Tubes acier inoxydable Edelstahlrohr	1150x 580x h1560 mm	6 - 7	30 Kg	CAD00166 
<b>ERCOLE CR EASY</b>	max. 200 Kg	2 swivel and 2 fixed x Ø160 mm	Sheet metal desk and steel tube Lamiera e tubo di acciaio Tôle et tube en acier Blech- und Stahlrohr	1440x 660x h950 mm	10 - 12	36 Kg	CAD1894.1 



## ERCOLE CR S / L



ERCOLE CR L

## ERCOLE BR S / L



ERCOLE BR S

- EN**
- Non marking and full wrap-around rubber bumper
  - Durable carpet made of 100% Polypropylene
  - Sheathed handle with plastic grip (BR S/L)

- FR**
- Pare-chocs intégral en caoutchouc gris clair
  - Moquette très résistante 100% polypropylène
  - Poignée gainée (BR S/L)

- IT**
- Bordo paracolpo in gomma antitraccia
  - Moquette di lunga durata in polipropilene 100%
  - Impugnatura in plastica (BR S/L)

- DE**
- Nicht abfärbender rundum Gummistoßschutz
  - Strapazierfähiger Teppich aus 100% Polypropylen
  - Ummantelter Handgriff aus Kunststoff (BR S/L)

## Options



## Available colours



Grey | Grigio | Gris | Grau



Blue | Blu | Bleu | Blau



Red | Rosso | Rouge | Rot



Black | Nero | Noir | Schwarz

							
<b>ERCOLE CR S</b>	max. 300 Kg	2 swivel and 2 fixed x Ø200 mm 'RG'	Steel tube with chrome finish Ø28 mm	891x 591x h1044 mm	6 - 8	25 Kg	010401CR
<b>ERCOLE CR L</b>			Tubo in acciaio cromato Ø28 mm Tubes acier chromé Ø28 mm Stahlrohr verchromt Ø28 mm	1091x 591x h1044 mm	8 - 10	30 Kg	010402CR
<b>ERCOLE BR S</b>			Brassed steel tube Ø28 mm Tubo in acciaio ottonato Ø28 mm Tubes acier laitonné Ø28 mm	891x 591x h1044 mm	6 - 8	25 Kg	010401BR
<b>ERCOLE BR L</b>			Stahlrohr vermessingt Ø28 mm	1091x 591x h1044 mm	8 - 10	30 Kg	010402BR

## ROLLBAG

NEW



ROLLBAG + R1 ROLLBAG



- EN**
- Nestable
  - 2 side panels with labeling space
  - Foldable space-saving base and side panels
  - Mesh dimensions: 120x50 mm (base), 100x150 mm (sides), 150x150 mm (backside)
  - 2 swivel castors and 2 fixed with brake

- FR**
- Emboîtable
  - 2 panneaux latéraux avec plaques d'identification
  - Panneaux de base et latéraux refermables pour un petit encombrement
  - Maille: 120x50 mm (socle), 100x150 mm (panneaux latéraux), 150x150 mm (panneau arrière)
  - 2 roues pivotantes et 2 fixes avec frein

- IT**
- Impilabile
  - 2 pannelli laterali, uno con placca porta etichette
  - Base e pannelli laterali richiudibili per un minimo ingombro
  - Dimensioni maglia: 120x50 mm (base), 100x150 mm (pannelli laterali), 150x150 mm (pannello posteriore)
  - 2 ruote girevoli e 2 ruote fisse con freno

- DE**
- Stapelbar
  - 2 Seitenwände mit Beschriftungsplatten
  - Basis- und Seitenwände für geringen Platzbedarf wiederverschließbar
  - Maschenabmessungen: 120 x 50 mm (Basis), 100x150 mm (Seiten), 150x150 mm (Rückseite)
  - 2 Brems-Bockrollen, davon 2 Lenkrollen

## Options



<b>ROLLBAG</b>	max. 500 Kg	2 swivel and 2 fixed x Ø125 mm Nylon+Tpu	Steel tube frame with wire mesh, electrolytically galvanized Struttura in tubo e filo d'acciaio, con zincatura brillante Tubes et fils d'acier, finition électro-galvanisée Rohr- und Drahtkonstruktion, elektrolytisch verzinkt	1200x 845x 1700h mm	45 Kg	CAD00216

## MASTERINOX 500

## MASTERINOX EASY



MASTERINOX 500

**NEW**





MASTERINOX EASY

- EN** • Full stainless steel sheet platform  
• Stainless steel tube handle  
• Pushing handle

- IT** • Piattaforma liscia in acciaio inox  
• Manico in tubo inox  
• Maniglione di spinta

- FR** • Plateau en acier inoxydable  
• Poignée en tube d'acier inoxydable  
• Poignée de poussée

- DE** • Edelstahl Bodenplatte  
• Rohrgriff aus Edelstahl  
• Mit Schiebebügel

	 KG				 KG	 CODE
<b>MASTERINOX 500</b>	max. 500 Kg	2 swivel and 2 fixed Ø200 mm	Stainless steel Acciaio inox Acier inoxydable Edelstahl	1060x 560x h1045 mm	25 Kg	100302IN
<b>MASTERINOX EASY</b>	max. 200 Kg	2 swivel and 2 fixed Ø 140 mm		1100x 600x h970 mm	15 Kg	CAD00165



## ROULSTAR ECO

**NEW**



ROULSTAR ECO

## ROULSTAR EASY

**NEW**







ROULSTAR EASY

- EN** • Polyethylene based  
 • Pushing handle foldable (ECO) or fixed (EASY) handle

- IT** • Base in polietilene  
 • Maniglione di spinta pieghevole (ECO) o fisso (EASY)

- FR** • Plateau en polyéthylène  
 • Poignée de poussée pliable (ECO) ou fixe (EASY)

- DE** • Bodenplatte in Polyethylen  
 • Mit Schiebebügel  
 • Faltbarer (ECO) und fester (EASY) Griff

						
<b>ROULSTAR ECO</b>	max. 200 kg	2 swivel and 2 fixed x Ø140 mm	Steel tube and polyethylene Tubo in metallo e polietilene	950x 570x h870 mm	13 Kg	CAD00164
<b>ROULSTAR EASY</b>			Tube en acier et polyéthylène Stahlrohr und Polyethylen	1070x 570x h970 mm		





- EN**
- Nestable
  - 1 front bumper
  - Neutral plate

- IT**
- Impilabile
  - Paracolpo nella parte frontale
  - Placca neutra

- FR**
- Emboîtable
  - Pare-chocs de protection avant
  - Plaque neutre

- DE**
- Stapelbar
  - Plattform leicht geneigt
  - Neutrale Werbeplatte



- EN**
- Nestable
  - 1 front bumper
  - Upper basket for hand luggage, with hook for bags

- IT**
- Impilabile
  - Paracolpo nella parte frontale
  - Cestino superiore per bagagli a mano con gancio per borse

- FR**
- Emboîtable
  - Pare-chocs de protection avant
  - Panier supérieur pour bagages à main, porte sac intégré à l'avant

- DE**
- Stapelbar
  - Plattform leicht geneigt
  - Oberer Korb für Handgepäck, mit Taschenaufhängung

### Options Colysee



### Options Equinox 27



<b>COLYSEE</b>	max. 250 Kg	2 swivel front x Ø125 mm, 2 rear light grey fixed x Ø300 mm 'PNP'	Steel tube with epoxy coating RAL 9007 Acciaio inox, rivestimento epossidico grigio RAL 9007 Tubes acier peinture epoxy RAL 9007 Stahlrohr pulverbeschichtet in RAL 9007	920x 575x h1000 mm	3 - 4	17 Kg	99643055
<b>EQUINOX 27</b>	max. 300 Kg	2 swivel front x Ø125 mm, 2 rear x Ø200 mm with ball bearing, with rubber tread	Steel tube electrolytic galvanized, with clear coat Struttura in tubo d'acciaio con zincatura elettrolitica con copertura in vernice trasparente Tubes acier finition électro galvanisée vernie Stahlrohr verzinkt, mit Klarlacküberzug	930x 645x h1000 mm	3 - 5	18 Kg	99642703



## VOLO



- EN** • Nestable  
• 2 front donut bumper  
• Upper basket for hand luggage, with hook for bags

- IT** • Impilabile  
• 2 paracolpi frontali  
• Cestino superiore per bagagli a mano con gancio per borse

- FR** • Emboîtable  
• 2 pare-chocs angulaire à l'avant  
• Panier supérieur pour bagages à main, porte sac intégré à l'avant

- DE** • Stapelbar  
• 2 Abweisringe  
• Oberer Korb für Handgepäck, mit Taschenaufhängung

## Options Volo

N/P- VOLO



LOGO



## VOLO GR

NEW



- EN** • Nestable  
• 2 front donut bumper  
• Upper basket for hand luggage and clothes hanger bar

- IT** • Impilabile  
• 2 paracolpi frontali  
• Cestino superiore per bagagli a mano e barra appendiabiti

- FR** • Emboîtable  
• 2 pare-chocs angulaire à l'avant  
• Panier supérieur pour bagages à main et barre penderie pour cintres

- DE** • Stapelbar  
• 2 Abweisringe  
• Oberer Korb für Handgepäck, mit Taschenaufhängung  
• Kleiderbügel

## Options Volo GR

N/P- VOLO



LOGO



<b>VOLO</b>	max. 250 Kg	2 swivel front x Ø125 mm and 2 rear x Ø200 mm, with ball bearing, with rubber tread	Steel tube electrolytic galvanized, with clear coat Struttura in tubo d'acciaio con zincatura elettrolitica con copertura in vernice trasparente	1015x 600x h970 mm	3 - 4	18 Kg	VOLO001
<b>VOLO GR</b>			Tubes acier finition électro galvanisée vernie Stahlrohr verzinkt, mit Klarlacküberzug	1015x 600x h1700 mm		19,5 Kg	CAD00061



## SPIGA

## CORD



SPIGA BR

SPIGA IN



CORD R BR





CORD B CR

CORD N CR

CORD Z BR

- EN** • Possibility to add Display or ropes  
• Head with hollowed crown so as to fix a snap hook
- IT** • Possibilità di aggiungere Display o corde  
• Disco piatto con ghiera per il fissaggio di moschettoni
- FR** • Possibilité d'ajouter des panneaux d'informations ou des cordes  
• Tête avec couronne évidée
- DE** • Möglichkeit zum Hinzufügen von Display oder Kordeln  
• Flacher Kopf mit Befestigung für Kordel-Karabiner

- EN** • Twisted rope 1500 mm available in: red, blue, cream and black  
• Snap hook in steel (CR) or brassed finish (BR)
- IT** • Corda intrecciata 1500 mm disponibile in: rosso, blu, crema e nero  
• Moschettoni in acciaio (CR) o finitura ottonata (BR)
- FR** • Cordon torsadé 1500 mm disponible en: rouge, bleu, crème et noir  
• Mousqueton en acier inoxydable (IN) ou finition laiton (BR)
- DE** • Gedrehte Kordel 1500 mm erhältlich in: rot, blau, beige und schwarz  
• Karabinerhaken aus Stahl verchromt (CR) oder vermessingt (BR)

				
<b>SPIGA IN</b> <b>SPIGA BR</b>	Stainless steel with chrome (IN) / brass (BR) finish Acciaio inox con finitura cromata (IN) / ottonata (BR) Tubes acier inoxydable chromé (IN) / finition laiton (BR) Edelstahl, verchromt (IN) / Stahl, vermessingt (BR)	Ø base 360x Ø post 50x h910 mm Ø base 360x Ø tubo 50x h910 mm Ø base 360x Ø poteau 50x h910 mm Ø base 360x Ø Pfosten 50x h910 mm	13 Kg	030100IN 030100BR
<b>CORD R CR</b> <b>CORD R BR</b>	Red, chrome snap hook finish (CR) / Red, brass snap hook finish (BR) Corda rossa con moschettoni cromati (CR) / ottonati (BR) Rouge: mousqueton finition chromée (CR) / laiton (BR) Rot, Endstück verchromt (CR) / Rot, Endstück vermessingt (BR)	1500 mm	0.8 Kg	030301CR 030301BR
<b>CORD B CR</b> <b>CORD B BR</b>	Blue, chrome snap hook finish (CR) / Blue, brass snap hook finish (BR) Corda blu con moschettoni cromati (CR) / ottonati (BR) Bleu: mousqueton finition chromée (CR) / laiton (BR) Blau, Endstück verchromt (CR) / Blau, Endstück vermessingt (BR)	1500 mm	0.8 Kg	030302CR 030302BR
<b>CORD N CR</b> <b>CORD N BR</b>	Cream, chrome snap hook finish (CR) / Cream, brass snap hook finish (BR) Corda color crema con moschettoni cromati (CR) / ottonati (BR) Crème: mousqueton finition chromée (CR) / laiton (BR) Beige, Endstück verchromt (CR) / Beige, Endstück vermessingt (BR)	1500 mm	0.8 Kg	030303CR 030303BR
<b>CORD Z CR</b> <b>CORD Z BR</b>	Black, chrome snap hook finish (CR) / Black, brass snap hook finish (BR) Corda nera con moschettoni cromati (CR) / ottonati (BR) Noir: mousqueton finition chromée (CR) / laiton (BR) Schwarz, Endstück verchromt (CR) / Schwarz, Endstück vermessingt (BR)	1500 mm	0.8 Kg	030304CR 030304BR

## RIGA



RIGA BR

RIGA IN

## CORDA



CORDA R CR



CORDA B BR



CORDA N CR

NEW



- EN** • Possibility to add Display (with opt. Supp) or ropes  
• Head with hollowed crown so as to fix a snaphook

- IT** • Possibilità di aggiungere Display, con l'ausilio del Supp o corde  
• Disco piatto con ghiera per il fissaggio di moschettoni

- FR** • Possibilité d'ajouter des panneaux d'informations avec option Supp ou des cordes  
• Tête avec couronne évidée

- DE** • Möglichkeit zum Hinzufügen von Display (mit opt. Supp) oder Kordeln  
• Flacher Kopf mit Befestigung für Kordel-Karabiner

- EN** • Twisted rope 1500 mm available in: red, blue and black  
• Snap hook in steel (CR) or brassed finish (BR)

- IT** • Corda intrecciata 1500 mm disponibile in: rosso, blu e nero  
• Moschettoni in acciaio (CR) o finitura ottonata (BR)

- FR** • Cordon torsadé 1500 mm disponible en: rouge, bleu et noir  
• Mousqueton en acier inoxydable (IN) ou finition laiton (BR)

- DE** • Gedrehte Kordel 1500 mm erhältlich in: rot, blau und schwarz  
• Karabinerhaken aus Stahl verchromt (CR) oder vermessingt (BR)

<b>RIGA IN</b> <b>RIGA BR</b>	Stainless steel with matt (IN) / brass (BR) finish Acciaio inox (IN) / con finitura ottonata (BR) Tubes acier inoxydable brossé (IN) / finition laiton (BR) Edelstahl Stahl (IN) / Stahl, vermessingt (BR)	Ø base 320x Ø post 50x h970 mm Ø base 320x Ø tubo 50x h970 mm Ø base 360x Ø poteau 50x h910 mm Ø base 320x Ø Pfosten 50x h970 mm	5,5 Kg	CAD00086 CAD00045
<b>CORDA R CR</b> <b>CORDA R BR</b>	Red, chrome snap hook finish (CR) / Red, brass snap hook finish (BR) Corda rossa con moschettoni cromati (CR) / ottonati (BR) Rouge: mousqueton finition chromée (CR) / laiton (BR) Rot, Endstück verchromt (CR) / Rot, Endstück vermessingt (BR)	1500 mm	0.6 Kg	CAD00087 CAD00089
<b>CORDA B CR</b> <b>CORDA B BR</b>	Blue, chrome snap hook finish (CR) / Blue, brass snap hook finish (BR) Corda blu con moschettoni cromati (CR) / ottonati (BR) Bleu: mousqueton finition chromée (CR) / laiton (BR) Blau, Endstück verchromt (CR) / Blau, Endstück vermessingt (BR)	1500 mm	0.6 Kg	CAD00088 CAD00090
<b>CORDA N CR</b> <b>CORDA N BR</b>	Black, chrome snap hook finish (CR) / Black, brass snap hook finish (BR) Corda nera con moschettoni cromati (CR) / ottonati (BR) Noir: mousqueton finition chromée (CR) / laiton (BR) Schwarz, Endstück verchromt (CR) / Schwarz, Endstück vermessingt (BR)	1500 mm	0.6 Kg	CAD00214 CAD00215

## RETRAX / WALL A &amp; B



RETRAX BR

RETRAX IN

RETRAX INS

RETRAX BK



WALL A



WALL B

## Available colours



## Options



- EN RETRAX**
- Length of belt 2500 mm

- WALL A**
- Black steel casing
  - Length of the belt 2500 mm

- WALL B**
- Stainless steel clip to be used opposite to WALL A or RETRAX

- IT RETRAX**
- Lunghezza nastro 2500 mm

- WALL A**
- Conchiglia colore nero
  - Lunghezza nastro 2500 mm

- WALL B**
- Ricevitore nastro in acciaio inox

- FR RETRAX**
- Longueur de la sangle: 2500 mm

- WALL A**
- Coque en acier peint finition noire
  - Longueur de la sangle: 2500 mm

- WALL B**
- Clip de fixation de sangle à installer pour recevoir la sangle du WALL A ou du RETRAX

- DE RETRAX**
- Zugband mit einer Länge von ca. 2500 mm

- WALL A**
- Schwarz lackiertes Stahlgehäuse
  - Bandlänge ca. 2500 mm

- WALL B**
- Edelstahl-Wandhalterung für Zugband

<b>RETRAX BR</b>	Stainless steel with brass finish Acciaio inox con finitura ottonata Tubes acier inoxydable finition laiton Edelstahl vermessingt	Ø base 340x Ø post 64x h985 mm	14 Kg	030401BR
<b>RETRAX IN</b>	Stainless steel with chrome finish Acciaio inox con finitura cromata Tubes acier inoxydable chromé Edelstahl glänzend	Ø base 340x Ø post 64x h985 mm	14 Kg	030401IN
<b>RETRAX INS</b>	Stainless steel with brush finish Acciaio inox con finitura spazzolata Tubes acier inoxydable brossé Edelstahl matt	Ø base 340x Ø post 64x h985 mm	14 Kg	030401INS
<b>RETRAX BK</b>	Steel with black matt finish Acciaio con finitura nera opaca Tubes acier finition noire Stahlrohr schwarz pulverbeschichtet	Ø base 340x Ø post 64x h985 mm	14 Kg	030401BK
<b>WALL A</b>	Painted steel Acciaio verniciato Acier peint Lackierter Stahl	Ø 70 x h110	1 Kg	030402
<b>WALL B</b>	Stainless Steel Acciaio Inox Acier Inoxydable Edelstahl	-	0.5 Kg	030403

# INFO / DISPLAY



INFO A4 IN



INFO A3 BR



DISPLAY A4 BR



DISPLAY A3 CR

## Options



### EN INFO KIT

- Info Kit is composed of DISPLAY and SPIGA and optional SUPP

### DISPLAY

- Information panels can be used in portrait or landscape orientation

### IT INFO KIT

- Il Kit Info è composto da DISPLAY e SPIGA con l'ausilio dell'optional SUPP

### DISPLAY

- Pannello display che può essere usato sia in posizione orizzontale che verticale

### FR INFO KIT

- Le Kit Info est composé par le poteau SPIGA et le panneau d'information DISPLAY avec option SUPP

### DISPLAY

- Panneau d'information versatile en format portrait ou paysage.

### DE INFO KIT

- Das Info-Kit besteht aus DISPLAY und SPIGA (mit opt. Supp)

### DISPLAY

- Informationstafeln können im Hoch- oder Querformat verwendet werden

<b>DISPLAY A4 CR</b> <b>DISPLAY A4 BR</b>	Outer frame chrome with black inner frame (CR) / gold-colored inner frame (BR) Display cromato, con cornice interna nera (CR) / dorata (BR) Cadre intérieur noir (CR) / doré (BR)	275x 360 mm	1 Kg	030201CR 030201BR
<b>DISPLAY A3 CR</b> <b>DISPLAY A3 BR</b>	Infotafel DISPLAY mit innerem schwarzen Rahmen (CR) / innerem goldoptik Rahmen (BR)	360x 485 mm	1.5 Kg	030202CR 030202BR
<b>INFO A4CR</b> <b>INFO A4BR</b>	Steel base with chrome (CR) and brass finish (BR) / Outer frame chrome with black inner frame (CR) / gold-colored inner frame (BR) Colonnina cromata (CR) / ottonata (BR) con display cromato con cornice interna nera (CR) / dorata (BR)	275x 360 mm	14 Kg	030201CR KIT 030201BR KIT
<b>INFO A3CR</b> <b>INFO A3BR</b>	Poteau et pied en acier, finition chromée (CR) / laiton (BR), cadre intérieur noir (CR) / doré (BR) Absperirständer SPIGA in Stahl verchromt (CR) / vermessingt (BR) mit Infotafel DISPLAY mit innerem schwarzen Rahmen (CR) / innerem goldoptik Rahmen (BR)	360x 485 mm	14.5 Kg	030202CR KIT 030202BR KIT





# HOUSEKEEPING

**EN** As a pioneer in the sector, we have built a strong experience which gives us a solid understanding of what is needed for a professional and efficient housekeeping service.

**IT** **Pionieri del settore**, abbiamo acquisito una forte esperienza che ci permette di capire i bisogni dei nostri clienti per un servizio ai piani professionale ed efficace.

**FR** **Pionnier dans ce secteur**, nous avons acquis une forte expérience, contribuant ainsi à une solide compréhension des besoins de nos clients, pour un travail professionnel et efficace dans les étages.

**DE** **Als der Pionier** in diesem Bereich wissen wir, worauf es bei einem professionellen und effektiven Housekeeping ankommt.



NEW



BALI KIT

- EN**
- 2 height adjustable shelves
  - Lockable doors and lid (OPT)
  - 4 donut bumpers

- IT**
- 2 ripiani regolabili in altezza
  - Porte e coperchio muniti di serratura (OPT)
  - 4 ruote paracolpo ricoperte di gomma antitraccia

- FR**
- 2 étagères ajustables
  - Portes et couvercle verrouillables (OPT)
  - Pare-chocs angulaire

- DE**
- 2 höhenverstellbare Einlegeböden
  - Abschließbare Tür und Deckel (OPT)
  - 4 Abweisringe

### Options



### Panel Finish







**SATELLITE**  
removable trolley with  
waste bag and cover



BALI  
(CAD00210) + OPTIONS: SATELLITE, SAC, LID,  
KC, DH, D, RNY

**BALI KIT: Fully operational solutions**







**Basic model**

**Option PVC**



**Option SAC**



							
<b>BALI</b>	max. 150 Kg	4 swivel x Ø150 mm 'CMP', 2 of which with brake	Steel tubing structure with HPL panels Struttura in tubo d'acciaio con pannelli HPL Structure en tubes d'acier avec panneaux en HPL Stahlrohrrahmen mit HPL-Platten	1600x 610x h1300 mm	9 - 12	68 Kg	CAD00210



1



## Trendie

- EN Turn-down service bag. Compact, ergonomic and versatile quick solution for an impeccable service.
- IT Borsa per il servizio alle camere. Soluzione rapida e compatta, ergonomica e versatile, per un servizio rapido e impeccabile.
- FR Sac Turn-Down compact pour un service polyvalent impeccable, rapide et ergonomique.
- DE Faltbare Servicetasche: Eine kompakte, ergonomische und vielseitige Lösung für einen tadellosen, schnellen Service.



1



2

+ 2

## Handie

- EN Customizable housekeeping trolley. Discreet, silent and lightweight cart for a stylish and efficient service.
- IT Carrello per le pulizie personalizzabile. Discreto, silenzioso e leggero per un servizio elegante ed efficiente.
- FR Valisette personnalisable pour un service d'étage élégant, discret, silencieux et efficace.
- DE Anpassbarer Reinigungswagen. Dezent, leise und leicht für einen eleganten und effizienten Service.



3



= 3

## Buddie

- EN A complete set of 2 separate elements brought together for an impeccable and efficient invisible housekeeping service.
- IT Un set completo di 2 elementi separati riuniti per un servizio di pulizia invisibile, impeccabile ed efficiente.
- FR Un ensemble comprenant le deux différents éléments pour un service en chambre complet.
- DE Die Kombination aus 2 separaten Elementen sorgt für ein unsichtbares und gleichzeitig effizientes Housekeeping.



- EN**
- 1 Heavy duty fastening strap secures the Trendie from falling
  - 2 Strong with elastic fastening or strap wraps around the sticks on pocket with removable and washable plastic pocket liners for an unmatched hygiene.
  - 3 Rigid plastic drawer with inner adjustable velcro dividers that can be washed and rinsed with water

- FR**
- 1 Une solide sangle permet de fixer le Trendie
  - 2 Le contenu des poches est protégé par des sangles élastiques et résistantes. Les séparateurs sont amovibles et lavables.
  - 3 Casier en plastique rigide avec séparateurs velcro amovibles. Lavable à l'eau.

- IT**
- 1 Fascia elastica di fissaggio
  - 2 Tasche dotate di fodere con velcro o fisse in plastica lavabili per un'igiene impareggiabile.
  - 3 Divisori interni regolabili in plastica rigida. I divisori possono essere rimossi e il cassetto può essere lavato.

- DE**
- 1 Mit Aufsteckband zum Fixieren am HANDIE.
  - 2 Die beiden Seitentaschen wurden zum Verstauen von Reinigungsmitteln und z.B. 1 Besen konzipiert und sind abwaschbar.
  - 3 Die Schubladen sind komplett herausnehmbar. Sie verfügen über ein Trennwandsystem auf Klettverschlussbasis, das abnehmbar sowie waschbar ist.



## Options



## Available colours



RE - Red BR - Brown BL - Blue BK - Black RAL 15 pieces MOQ.

**TOTALLY  
CUSTOMIZABLE**

XX=\*CODE COLOR  
COD. COLORE  
CODE COULEUR  
FARB CODE

<b>TRENDIE</b>	max. 10/15 Kg	-	PVCP (Hydrorepellent PVC-coated Polyester 600)	450x 380x h270 mm	1	2,9 Kg	050602XX*
<b>HANDIE</b>	max. 25/30 Kg	2 x Ø 110 mm 2 x Ø 50 mm	PVCP (poliestere 600 idrorepellente rivestito in PVC) PVCP (imperméable recouvert en polyester 600)	450x 380x h620 mm	2	8,8 Kg	050601XX*
<b>BUDDIE</b>	max. 35/45 Kg	2 x Ø 110 mm 2 x Ø 50 mm	Wasserdichtes PVC-beschichtetes Polyester 600	450x 380x h890 mm	2-3	11,7 Kg	050603XX*



**EN** The PALACE has been designed as a contemporary and stylish piece of mobile furniture which would complement any luxury hotel environment. Innovative and functional internal usable space can be customised to suit the operational needs

**FR** PALACE est une belle pièce de mobilier personnalisable aux lignes contemporaines et sobres. Son intérieur cache des trésors de fonctionnalités et son extérieur viendra compléter la décoration de votre établissement.

**IT** Pensato e sviluppato per essere più un complemento d'arredo che un carrello housekeeping, il modello PALACE è caratterizzato da linee contemporanee che nascondono al loro interno molteplici funzionalità.

**DE** PALACE ist im Inneren ein Zimmermädchenwagen mit allen wichtigen wie praktischen Details. Das Äußere besticht durch seine zeitgenössische und gleichzeitig dezente Aufmachung, die dank einer Vielzahl an Oberflächen-Ausführungen individuell an das jeweilige Interieur angepasst werden kann.

**Options**



\* Optional not compatible with RS5

<b>PALACE</b>	max. 150 Kg	2 swivels and 2 fixed x Ø160 mm	Completely customizable Completamente personalizzabile Complètement personnalisable Individuelles Design	1600x 610x h1300 mm	3 - 5	050106



- EN**
- 1** Full range of leather and textured materials for the outer panels as well as matching handles, locks and castors. Personalized finishes for metal parts
  - 2** Linen bag on rails
  - 3** Left interior side with pull out storage drawer for garbage and for linen
  - 4** Extra drawer and compartments e.g. for cleaning products
  - 5** Concealed sliding doors
  - 6** Right interior side with 3 shelves, 2 drawers
  - 7** With opt. E-DRIVE: 4 swiveling castors

- IT**
- 1** Intera gamma di pelle e tessuto per il rivestimento esterno. Maniglie in coordinato e parti di metallo personalizzabili
  - 2** Sacco in poliestere su guide estraibili
  - 3** Nel lato interno sinistro cassetto per raccolta rifiuti e biancheria
  - 4** Cassetto extra e scompartimenti per prodotti di pulizia
  - 5** Porte scorrevoli a scomparsa
  - 6** Nel lato interno destro 3 ripiani e 2 cassetti
  - 7** Con opt. E-DRIVE: 4 ruote girevoli Ø160 mm 'RNY'

- FR**
- 1** Palette complète de cuirs et de matériaux texturés ou lisses pour la finition extérieure.
  - 2** Poignées, serrures et roulettes assorties. Peinture personnalisée des pièces métalliques.
  - 3** Sac pour linge sale, sur glissières
  - 4** Intérieur gauche: Corbeille à déchet, sur glissière Tiroir supplémentaire et compartiment pour produits d'accueil et de nettoyage
  - 5** Kit de portes rabattable en intérieur
  - 6** Intérieur côté droit : 3 étagères et 2 tiroirs
  - 7** Si opt. E-DRIVE: 4 roulettes pivotantes

- DE**
- 1** Große Auswahl an Oberflächen wie Leder- oder Stoffbezüge, Griffe und Schlösser
  - 2** Auszug mit Wäschesack
  - 3** Linke Innenraumseite mit Auszug für Müllsammel- und Wäschebehälter
  - 4** Weitere Schublade sowie Fächer z.B. für Reinigungsmittel
  - 5** Versenkbare Türe
  - 6** 2 Schubladen und 3 Fachböden
  - 7** Mit Option E-Drive: 4 Lenkrollen



TAHITI L



TAHITI S KIT + OPT. E/R AND BP

- EN**
- 2 height adjustable shelves
  - Non marking and full wrap-around rubber bumper
  - Top level with retaining bars

- IT**
- 2 ripiani regolabili in altezza
  - Bordo paracolpo in gomma antistraccia
  - Ripiano superiore con spondine di protezione

- FR**
- 2 étagères ajustables
  - Pare-chocs intégral non-marquant
  - Plateau supérieur avec barres de rétention

- DE**
- 2 höhenverstellbare Einlegeböden
  - Nicht abfärbender rundum Gummistoßschutz
  - Oberste Ebene mit Schutzreling

<b>TAHITI S</b>		4 swivel x Ø150 mm CMP; 2 of which with brake	Steel tubing structure with HPL panels Struttura in tubo d'acciaio con pannelli HPL Structure en tubes d'acier avec panneaux en HPL Stahlrohrrahmen mit HPL-Platten	1350x 566x h1491mm	7 - 10	37 Kg	050202HPL
<b>TAHITI M</b>	max. 150 Kg			1550x 566x h1491mm	10 - 13	44 Kg	050203HPL
<b>TAHITI L</b>				1770.5x 566x h1491mm	13 - 16	52 Kg	050204HPL



TAHITI L KIT

**BESTSELLER**

**TAHITI KIT: Fully operational solutions**

Basic model (Tahiti S/M/L)

Option PVC + Option SAC

**Options**



**Panel Finish**

HPL



SFB

SOM

SWE

SNE



FIDJI S / M / L



FIDJI M



FIDJI S KIT + OPT. BP

- EN** • 2 height adjustable shelves  
 • Non marking and full wrap-around rubber bumper  
 • Top level with retaining bars

- IT** • 2 ripiani regolabili in altezza  
 • Bordo paracolpo in gomma antitraccia  
 • Ripiano superiore con spondine di protezione

- FR** • 2 étagères ajustables  
 • Pare-chocs intégral non-marquant  
 • Plateau supérieur avec barres de rétention

- DE** • 2 höhenverstellbare Einlegeböden  
 • Nicht abfärbender rundum Gummistoßschutz  
 • Oberste Ebene mit Schutzreling

FIDJI < TAHITI → | 8 cm | ←

TAHITI 56.6 cm

FIDJI 48,5 cm

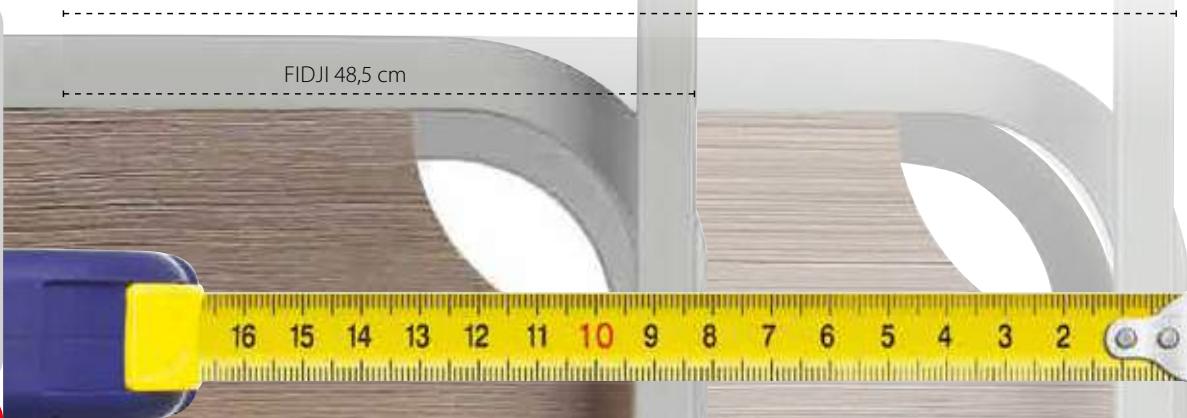





FIDJI L KIT+ OPT: BP, D, C

**FIDJI KIT: Fully operational solutions**

Basic model (Fidji S/M/L)



**Options**



**Panel Finish**



<b>FIDJI S</b>	max. 150 Kg	4 swivel x Ø 150 mm 'CMP', 2 of which with brake	Steel tubing structure with HPL panels Struttura in tubo d'acciaio con pannelli HPL Structure en tubes d'acier avec panneaux latéraux et arrière en HPL Stahlrohrrahmen mit HPL-Platten	1350x 485x h1491mm	5 - 8	27 Kg	050402HPL
<b>FIDJI M</b>				1550x 485x h1491mm	9 - 12	34 Kg	050403HPL
<b>FIDJI L</b>				1770.5x 485x h1491mm	12 - 15	42 Kg	050404HPL



## GEORGE S / M / L



GEORGE M + OPT: PVC, SAC, E



GEORGE L KIT

- EN** • 2 height adjustable shelves
- Non marking and full wrap-around rubber bumper
  - Top level and amenity box with adjustable separators for convenient organization

- FR** • 2 étagères ajustables
- Pare-chocs intégral non-marquant
  - Cavité supérieure avec séparateurs ajustables pour l'organisation des produits d'accueil

- IT** • 2 ripiani regolabili in altezza
- Bordo paracolpo in gomma antitraccia
  - Ripiano superiore dotato di un vano porta oggetti con separatori regolabili

- DE** • 2 höhenverstellbare Einlegeböden
- Nicht abfärbender rundum Gummistoßschutz
  - Oberste Etage mit integriertem Kleinartikelkasten mit variabler Inneneinteilung
  - Mit Schiebebügel

## Panel Finish

LAM





GEORGE S KIT

**GEORGE KIT: Fully operational solutions**

Basic model (George S/M/L)

Option PVC



Option SAC



**Options**



Options only available for the products marked with '\*'  
 Optional disponibile solo per i prodotti segnati con '\*'  
 Options seulement disponibles pour les produits désignés par '\*'  
 Optionen nur für die mit \* markierten Modelle

<b>GEORGE S</b>	max. 150 Kg	4 swivel x Ø150 mm 'CMP' 2 of which with brake	Laminated wood Legno laminato Bois mélaminé Melaminharzbeschichtetes Holz	1306.5x 570x h1474 mm	5 - 8	45 Kg	050102WD
<b>GEORGE M*</b>				1510x 570x h1474 mm	10 - 13	55 Kg	050103WD
<b>GEORGE L*</b>				1706x 570x h1474 mm	12 - 15	64 Kg	050104WD

**NEW**



- EN**
- 2 height adjustable shelves
  - Non marking and full wrap-around rubber bumper
  - Top level with amenity box with lid and adjustable separators for convenient organization

- IT**
- 2 ripiani regolabili in altezza
  - Bordo paracolpo in gomma antitraccia
  - Ripiano superiore dotato di un porta oggetti con separatori regolabili.

- FR**
- 2 étagères ajustables
  - Pare-chocs intégral non-marquant
  - Cavité supérieure avec séparateurs ajustables pour l'organisation des produits d'accueil

- DE**
- 2 höhenverstellbare Einlegeböden
  - Nicht abfärbender rundum Gummistoßschutz
  - Oberste Etage mit integriertem Kleinartikelkasten mit variabler Inneneinteilung

**Options**



**Panel Finish**

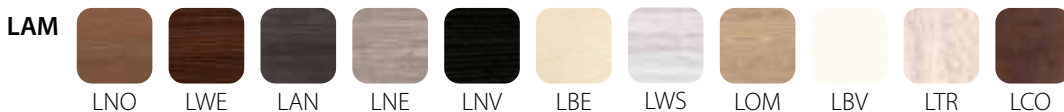

<b>GEORGE XL</b>	max. 150 Kg	4 swivel x Ø160 mm 'CMP', 2 of which with brake	Laminated wood Legno laminato Bois mélaminé Melaminharzbeschichtetes Holz	1834x 575x h1302 mm	15 - 20	050105WD



**ALU MADE** IMPROVED AND PERFECT FOR OUTDOOR USE.

DAKAR ALU  
(CAD00117) + OPTION: SAC, SAC, D, CC

- EN**
- 2 fixed shelves
  - Lockable aluminium doors
  - Non marking and full wrap-around rubber bumper

- IT**
- 2 ripiani fissi
  - Chiusura con porte munite di serratura
  - Bordo paracolpo in gomma antitraccia

- FR**
- 2 étagères fixes
  - Portes en aluminium verrouillables
  - Pare-chocs intégral non-marquant

- DE**
- 2 feste Einlegeböden
  - Abschließbare Türen
  - Nicht abfärbender rundum Gummistoßschutz

### DAKAR ALU KIT: Fully operational solutions

Basic model

Option PVC



+

Option SAC



### Options

BDX

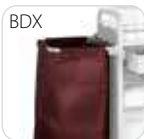

CC



D



PVC



PVC / BDX



PVC / SAC



RF



SAC



TL



<b>DAKAR ALU</b>	max. 150 Kg	4 swivel Ø160 mm	Anodized aluminum Alluminio anodizzato Aluminium anodisé Eloxiertes Aluminium	1544x 550x h1386 mm	9 - 12	48 Kg	CAD00117

NEW



- EN**
- Left interior side with pull out storage drawer for garbage and for linen
  - Extra drawer and compartments e.g. for cleaning products
  - Concealed sliding doors

- IT**
- Nel lato interno sinistro, un cassetto per raccolta rifiuti e biancheria
  - Cassetto extra e scompartimenti per prodotti di pulizia
  - Porte scorrevoli a scomparsa

- FR**
- Intérieur gauche: corbeille à déchets et à linge sale sur glissières
  - Tiroir supplémentaire et compartiment pour produits d'accueil et de nettoyage
  - Kit de portes rabattable à l'intérieur

- DE**
- Linke Innenraumseite mit Auszug für Müllsammel- und Wäschebehälter
  - Weitere Schublade sowie Fächer z.B. für Reinigungsmittel
  - Versenkbare Türe

### Options



### Panel Finish

LAM



LNO



LWE



LAN



LNE



LNV



LBE



LWS



LOM



LBV



LTR



LCO



- EN**
- 1 Linen bag on rails
  - 2 Left interior side with pull out storage drawer for garbage and for linen
  - 3 Extra drawer and compartments e.g. for cleaning products
  - 4 Concealed sliding doors
  - 5 Right interior side with 3 shelves, 2 drawers

- IT**
- 1 Sacco in poliestere su guide estraibili
  - 2 Nel lato interno sinistro cassetto per raccolta rifiuti e biancheria
  - 3 Cassetto extra e scompartimenti per prodotti di pulizia
  - 4 Porte scorrevoli a scomparsa
  - 5 Nel lato interno destro 3 ripiani e 2 cassetti

- FR**
- 1 Sac pour linge sale, sur glissières
  - 2 Intérieur gauche: Corbeille à déchet, sur glissière
  - 3 Tiroir supplémentaire et compartiment pour produits d'accueil et de nettoyage
  - 4 Kit de portes rabattable en intérieur
  - 5 Intérieur côté droit : 3 étagères et 2 tiroirs

- DE**
- 1 Auszug mit Wäschesack
  - 2 Auszug für Müllsack
  - 3 Weitere Schublade sowie Fächer z.B. für Reinigungsmittel
  - 4 Versenkbare Türen
  - 5 Rechte Innenraumseite mit 3 höhenverstellbare Einlegeböden und 2 Schubladen

<b>PALACE EASY</b>	max. 150 Kg	2 swivel and 2 fixed x Ø160 mm 'RNY'	Laminated wood Legno laminato Bois mélaminé Melaminharzbeschichtetes Holz	1080x 580x h1545 mm	3 - 5	CAD00201



## CAPRI

**NEW**



## CAPRI ECO

**NEW**



- |  |   |
|--|---|
| <p><b>EN</b></p> <ul style="list-style-type: none"> <li>• 1 fixed shelf (CAPRI) / 2 adjustable shelves (CAPRI ECO)</li> <li>• Lockable plastic doors</li> <li>• 2 removable bags with zip (CAPRI ECO)</li> <li>• Auxiliary lower drawer</li> <li>• Top shelf with hedges</li> <li>• 4 donut bumpers</li> </ul>   | <p><b>IT</b></p> <ul style="list-style-type: none"> <li>• 1 ripiano fisso (CAPRI) / 2 ripiani regolabili (CAPRI ECO)</li> <li>• Chiusura con porte munite di serratura</li> <li>• 2 borse rimovibili con zip (CAPRI ECO)</li> <li>• Compartimento inferiore ausiliario</li> <li>• Ripiano superiore con protezione</li> <li>• 4 ruote paracolpo ricoperte di gomma antitraccia</li> </ul> |
| <p><b>FR</b></p> <ul style="list-style-type: none"> <li>• 1 étagère fixe (CAPRI) / 2 étagères réglables (CAPRI ECO)</li> <li>• Fermeture avec portes verrouillables</li> <li>• 2 sacs amovibles avec fermeture éclair (CAPRI ECO)</li> <li>• Niveau inférieur</li> <li>• Tablette supérieure avec protection</li> <li>• 4 pare-chocs en caoutchouc non marquant</li> </ul> | <p><b>DE</b></p> <ul style="list-style-type: none"> <li>• 1 fester Fachboden (CAPRI) / 2 höhenverstellbare Einlegeböden (CAPRI ECO)</li> <li>• Abschließbare Kunststofftüren</li> <li>• 2 abnehmbare Taschen mit Reißverschluss</li> <li>• Zusätzliche untere Schublade</li> <li>• Oberes Regal mit Fallschutz</li> <li>• 4 Abweisrollen</li> </ul>                                       |

**PLASTIC MADE**  
**PERFECT FOR OUTDOOR USE.**  
**PERFETTO PER UN USO ALL'ESTERNO.**  
**IDÉAL POUR UTILISATION EXTÉRIEURE.**  
**PERFEKT FÜR DEN AUSSENEINSATZ.**

<b>CAPRI</b>	max. 150 Kg	2 swivel and 2 fixed x Ø200 mm, 2 of which with brake	Polypropylene Polipropilene Polypropylène Polypropylen	1530x 550x h1270 mm	12 - 15	CAD00119
<b>CAPRI ECO</b>	max. 120 Kg	2 swivel and 2 fixed x Ø200 mm, 2 of which with brake	High-density polyethylene (HDPE) Polietilene ad alta densità (HDPE) Polyéthylène haute densité (PE-HD) Polyethylen hoher Dichte (HDPE)	1530x 540x h1290 mm	12 - 15	CAD00119.G



# HALLEY 2 / 4



HALLEY 2



HALLEY 4

- EN**
- Lower full metal drawer (HALLEY 2)
  - Upper liftable holder for linen bag incl. polyester bag of 127 Ltr.
  - 4 non marking donut bumpers at the lower edges

- IT**
- Cassetto inferiore in metallo (HALLEY 2)
  - Supporto superiore per sacco biancheria completo di un sacco poliestere da 127 Ltr.
  - 4 ruote paracolpo ricoperte di gomma antistraccia

- FR**
- Tiroir métallique inférieur (HALLEY 2)
  - Support supérieur relevable avec sac 127 Ltr. en polyester inclus
  - 4 pare-chocs angulaires

- DE**
- Untere Metall-Schublade (HALLEY 2)
  - Obere klappbare Wäschesackhalterung inkl. Polyestersack 127Ltr. anthrazit
  - 4 Abweisinge

## Options



## Panel Finish

HPL



SFB



SOM



SWE



SNE

Options only available for the products marked with '\* \*'  
 Optional disponibile solo per i prodotti segnati con '\* \*'  
 Options seulement disponibles pour les produits désignés par '\* \*'  
 Optionen nur für die mit \* markierten Modelle

<b>HALLEY 2</b>	max. 150 Kg	2 swivel front x Ø150 mm and 2 fixed back x Ø300 mm 'PNP'	Steel tubing structure with HPL panels Struttura in tubo d'acciaio con pannelli HPL	628x 540x h1433mm	3 - 4	37 Kg	050401HPL
<b>HALLEY 4 *</b>		4 swivel x Ø150 mm 'CMP', 2 of which with brake	Structure en tubes d'acier avec panneaux HPL Stahlrohrrahmen mit HPL-Platten	810x 540x h1433mm	4 - 5	32 Kg	050401-4HPL



caddie



# PALACENET



PALACENET + OPT. BP

- EN**
- Non marking and full wrap-around rubber bumper
  - 1 inner compartment with height adjustable shelf
  - Lockable roller shutter

- IT**
- Bordo paracolpo in gomma antitraccia
  - Scompartimento interno con ripiano regolabile in altezza
  - Chiusura a serranda con chiave

- FR**
- Pare-chocs intégral non-marquant
  - 1 compartiment intérieur avec étagère amovible
  - Volet roulant verrouillable

- DE**
- Nicht abfärbender rundum Gummistoßschutz
  - Oberste Ebene mit Schutzreling
  - Abschließbarer Rollo

## Options



## Panel Finish



<b>PALACENET</b>	max. 150 Kg	4 swivel x Ø150 mm 'CMP', 2 of which with brake	Steel tubing structure with HPL panels Struttura in tubo d'acciaio con pannelli HPL Structure en tubes d'acier avec panneaux HPL Stahlrohrrahmen mit HPL-Platten	690x 565x h1320 mm	35 Kg	020100HPL

## IBIZA S / M / L



IBIZA M

- EN** • 2 height adjustable shelves  
 • Non marking and full wrap-around rubber bumper  
 • Double-sided upper liftable holders for waste bag and for polyester linen bag of 127 Ltr.

- IT** • 2 ripiani regolabili in altezza  
 • Bordo paracolpo in gomma antitraccia  
 • Supporto superiore pieghevole per sacco spazzatura in poliestere 127 Ltr. e sacco biancheria

- FR** • 2 étagères ajustables  
 • Pare-chocs intégral non-marquant  
 • Supports supérieurs pour sac poubelle et pour sac à linge 127 Ltr. en polyester

- DE** • 2 höhenverstellbare Einlegeböden  
 • Nach oben klappbare Müllsackhalterung  
 • Nach oben klappbare Wäschesackhalterung inkl. Polyestersack 127Ltr. anthrazit

## Options



## Panel Finish



<b>IBIZA S</b>			Steel tubing structure with HPL panels Struttura in tubo d'acciaio con pannelli HPL	1334.5x 566x h1491 mm	7 - 10	31 Kg	050502HPL
<b>IBIZA M</b>	max. 150 Kg	4 swivel x Ø 150 mm 'CMP'	Structure en tubes d'acier avec panneaux en HPL	1535.5x 566x h1491mm	10 - 13	38 Kg	050503HPL
<b>IBIZA L</b>			Stahlrohrrahmen mit HPL-Platten	1755x 566x h1491 mm	13 - 16	46 Kg	050504HPL



caddie



## EASY

NEW



EASY

## PONZA

NEW



PONZA

- EN** • 4 fixed shelves  
 • Rubber ring buffers (EASY)  
 • 2 lockable drawers (PONZA)  
 • 2 folding bag holders with canvas bag for dirty linen (EASY), 2 folding bag holders with nylon bags (PONZA)

- FR** • 4 étagères fixes  
 • Pare-chocs (EASY)  
 • 2 tiroirs avec serrure (PONZA)  
 • 2 supports supérieurs relevables avec sac en toile (EASY), 2 supports supérieurs relevables avec sac en nylon (PONZA)







- IT** • 4 piani fissi  
 • Paracolpi in gomma (EASY)  
 • 2 cassetti con serratura (PONZA)  
 • 2 reggisacco pieghevoli con sacco portabiancheria in tela (EASY), 2 reggisacco con sacco in nylon (PONZA)

- DE** • 4 feste Böden aus Melamin  
 • Gummipuffer  
 • 2 faltbeutelhalter mit 2 Baumwollsäcken (Easy) o. 2 Nylonsäck (Ponza)

## Options



Options only available for the products marked with '\*'  
 Optional disponibile solo per i prodotti segnati con '\*'  
 Options seulement disponibles pour les produits désignés par '\*'  
 Optionen nur für die mit \* markierten Modelle

						
<b>EASY *</b>	4 swivel x Ø150 mm	Stainless steel square tube Struttura in tubo d'acciaio quadrato Structure tube carré acier inoxydable Vierkantrohr Edelstahl	1200x 520x h1370 mm	4 - 5	26 Kg	050405IN 
<b>PONZA</b>	4 swivel x Ø150 mm, 2 of which with brake	Plastic and steel with rilsan coating Plastica e acciaio con rivestimento in rilsan Plastique et acier avec revêtement rilsan Kunststoff und Stahl mit Rilsanbeschichtung	1900x 550x h1520 mm	15 - 18	23 Kg	CAD00225 

## SAMOA S / M



SAMOA S

NEW



SAMOA M

NEW



caddie



- EN** • 2 fixed shelves  
 • Non marking and full wrap-around rubber bumper  
 • Upper liftable holder for canvas linen bag of 127 Ltr. (SAMOA S)  
 • Double-sided upper liftable holders for waste bag and for canvas linen bag of 127 Ltr. (SAMOA M)

- FR** • 2 étagères fixes  
 • Pare-chocs intégral non-marquant  
 • Support supérieur relevable pour sac à linge en toile 127 Ltr. (SAMOA S)  
 • Supports supérieurs pour sac poubelle et sac à linge en toile 127 Ltr. (SAMOA M)

- IT** • 2 ripiani fissi in altezza  
 • Bordo paracolpo in gomma antitraccia  
 • Supporto superiore pieghevole per sacco biancheria in tela 127 Ltr. (SAMOA S)  
 • Supporto superiore pieghevole per sacco biancheria in tela 127 Ltr. e uno in poliestere (SAMOA M)

- DE** • 2 feste Böden  
 • Nicht abfärbender rundum Gummistoßschutz  
 • Nach oben klappbare Müllsackhalterung (M)  
 • Nach oben klappbare Wäschesackhalterung inkl. Baumwollwäschesack 127 Ltr. (SAMOA S + M)

## Options



Options only available for the products marked with '\*'  
 Optional disponibile solo per i prodotti segnati con '\*'  
 Options seulement disponibles pour les produits désignés par '\*'  
 Optionen nur für die mit \* markierten Modelle

<b>SAMOA S</b>	max. 150 Kg	4 swivel x Ø 150 mm	Stainless steel frame with lateral laminated tobacco oak wood panels Struttura in acciaio inox con pannelli in legno nobilitato color rovere tabacco	720x 520x h1340 mm	7 - 10	32 Kg	CAD00229
<b>SAMOA M *</b>			Bois MDF finition Chêne Tabac, Edelstahlkonstruktion mit laminierten Holzplatten	870x 520x h1340mm	10 - 13	36 Kg	CAD00168

## AMBIENTE

NEW



## TRANSNET

NEW



- EN**
- Made with 100% recycled plastic
  - Equipped by: 2 upper buckets 6 Ltr. each, 2 buckets of 20 Ltr. each and mop wringer, 2 bucket baskets
  - Bag holder with bag cover and broom holder on the sides

- IT**
- Realizzato con plastica 100% riciclata
  - Dotato di: 2 secchi superiori 6 Ltr. cad., 2 secchi da 20 Ltr. cad. e strizzatore mop, 2 cestelli portasecchi
  - Reggisacco con coprisacco e portascopo sui fianchi

- FR**
- Fabriqué en plastique 100% recyclé
  - Chariot équipé avec 2 seaux supérieurs de 6 Ltr. chacun, 2 seaux inférieurs de 20 Ltr. chacun, 2 paniers porte-seaux, 1 essoreur
  - Support pour sac avec sac de cache et clip à balais

- DE**
- Aus 100% recycelbarem Kunststoff
  - Ausgestattet mit 2 Eimer je 6 Ltr., 2 Eimer je 20 Ltr. und Wringer
  - Mülleimerhalterung mit Deckel, Sichtschuttsack und Besenhalter

- EN**
- Chrome plated folding trolley, equipped with 2 bucket with wringer for mop
  - Equipped with broom clip
  - 1 red nylon bag 120 Ltr.

- IT**
- Carrello pieghevole completo di 2 secchi di cui uno con strizzatore per mop
  - Dotato di portamanico in gomma
  - Sacco in nylon rosso da 120 Ltr.

- FR**
- Chariot pliable équipé avec 2 seaux dont un avec essoreur
  - 1 clip à balais
  - 1 sac en nylon rouge 120 Ltr.

- DE**
- Verchromter und faltbarer Reinigungswagen, mit 2 Eimern und 1 Wringer
  - Ausgestattet mit Besenclip
  - 1 rote Nylontasche 120 Ltr.

<b>AMBIENTE</b>	4 swivel x Ø 80 mm	Steel tube and recycled plastic Struttura in tubo d'acciaio e plastica riciclata Tubes en acier chromé et plastique recyclé Stahlrohr verchromt und Kunststoff	930x 670x h1100 mm	14,8 Kg	CAD00228
<b>TRANSNET</b>		Chromed steel tube Struttura in tubo d'acciaio cromato Tubes en acier chromé Stahlrohr verchromt und Kunststoff	900x 510x h1000 mm	15 Kg	CAD00226



## PLASNET



- EN** • Upper basket with support clip for brooms  
• 2 buckets 15 Ltr. 1 wringer and 2 buckets 6 Ltr.

- IT** • Cestello superiore con clip per le scope  
• 2 secchi da 15 Ltr. ciascuno, 1 strizzatore e 2 secchi da 6 Ltr.

- FR** • Panier supérieur avec support clip pour balais  
• 2 seaux de 15 Ltr. 1 essoreur et 2 seaux de 6 Ltr.

- DE** • Mülleimerhalterung mit Deckel und Besenhalter  
• 2 Eimer 15 Ltr, 1 Wringer und 2 Eimer à 6 Ltr.

## FLOOR SAFETY SIGN



- EN** • Plastic floor sign with double side imprint  
• Dimensions: 300x h700 mm

- IT** • Pannello segnalatore completo di 2 dischi segnaletici  
• Dimensioni: 300x h700 mm

- FR** • Panneau sol mouillé  
• Dimensions: 300x h700 mm

- DE** • Bodenschild mit 2-seitigem Aufdruck in englisch  
• Maße: 300x h700 mm

					
<b>PLASNET</b>	4 swivel x Ø 100 mm with donut bumpers	Chromed steel tube Struttura in tubo d'acciaio cromata Tubes en acier chromé Stahlrohr verchromt und Kunststoff	1000 x 540 x h1150 mm	16,6 Kg	CAD00059 
<b>FLOOR SAFETY SIGN</b>	-	Plastic Plastica Plastique Kunststoff	-	1,4 Kg	CAD00039 



caddie







# LAUNDRY SERVICE

**EN Our know-how** in the development of transport and mobile storage carts and containers is based on ground experience. The outcome is a set of equipment featuring an easy and ergonomic handling style when fully loaded.

**IT La nostra abilità** nella creazione di carrelli e contenitori per il trasporto e lo stoccaggio della biancheria è data da anni di prove e test sul campo. Risultato: una gamma di prodotti maneggevoli ed ergonomici anche a pieno carico!

**FR Notre savoir-faire** dans le développement de chariots et containers de transport et stockage de linge est basé sur de nombreux essais et une mise en situation des produits. Résultat: un équipement combinant facilité de manœuvre et ergonomie, même chargé au maximum!

**DE Damit kennen wir uns aus:** Praxiserprobt und –bewährt sind unsere verschiedenen Transport- und Lagerbehälter, die selbst im beladenen Zustand leicht zu handhaben sind.



## CADDIE SAC

## CADDIE SAC HYDRO



CADDIE SAC



CADDIE SAC HYDRO

- EN** • Lower platform with metal bars  
 • Detachable laundry bag in polyester (CADDIE SAC) or a durable water repellent bag in burgundy (CADDIE SAC HYDRO)

- IT** • Piattaforma inferiore con barre di metallo  
 • Sacco biancheria amovibile, disponibile in 2 versioni: sacco in poliestere grigio (CADDIE SAC) o sacco idrorepellente bordeaux (CADDIE SAC HYDRO)

- FR** • Structure support inférieure anti-affaissement  
 • Sac détachable et lavable en Polyester (CADDIE SAC) ou en mix Polyester-nylon imperméable bordeaux (CADDIE SAC HYDRO)

- DE** • Stabile untere Ablage aus Metallstreben  
 • Abnehmbarer, waschbarer Wäschesack in grauem Polyester (CADDIE SAC), oder mit wasserabweisender, bordeauxroter Wäschesack (CADDIE SAC HYDRO)

<b>CADDIE SAC</b>	192 Ltr.	4 swivel x Ø125 mm "TPP" with donut bumpers, 2 of which with brake	Steel tube with grey powder coating Struttura in tubo d'acciaio verniciato color grigio	1030x 535x h922,5 mm	13 Kg	060100LN
<b>CADDIE SAC HYDRO</b>			Structure tubes d'acier peint gris clair Vierkant-Stahlrohr, pulverbeschichtet in grau			060100BDX

## CADDIE SAC XS



CADDIE SAC XS

## CADDIE SAC HYDRO XS









CADDIE SAC HYDRO XS

- EN**
- Lower platform with metal bars
  - Detachable laundry bag in polyester (CADDIE SAC XS) or a durable water repellent bag in burgundy (CADDIE SAC HYDRO XS)

- IT**
- Piattaforma inferiore e barre di metallo
  - Sacco biancheria amovibile, disponibile in 2 versioni: sacco in poliestere grigio, (CADDIE SAC XS) o sacco idrorepellente bordeaux (CADDIE SAC HYDRO XS)

- FR**
- Structure support inférieure anti-affaissement
  - Sac détachable et lavable en Polyester (CADDIE SAC XS) ou en mix Polyester-nylon imperméable bordeaux (CADDIE SAC HYDRO XS)

- DE**
- Stabile untere Ablage aus Metallstreben
  - Abnehmbarer, waschbarer Wäschesack in grauem Polyester (CADDIE SAC XS), oder mit wasserabweisender, bordeauxroter Wäschesack (CADDIE SAC HYDRO XS)
  - 4 Abweisinge

						
<b>CADDIE SAC XS</b>	150 Ltr.	4 swivel x Ø125 mm 'TPP' with donut bumpers, 2 of which with brake	Steel tube with grey powder coating Struttura in tubo d'acciaio verniciato color grigio	747,7x 535x h922,5 mm	12 Kg	060100LN XS
<b>CADDIE SAC HYDRO XS</b>			Vierkant-Stahlrohr, pulverbeschichtet in grau			060100BDX XS



## IBIZA TRISAC 2

## CADDIE X



IBIZA TRISAC 2



CADDIE X

- EN** • Lower platform with metal bars  
• 2 polyester bags included

- IT** • Piattaforma inferiore con barre di metallo  
• 2 sacchi poliestere inclusi

- FR** • Cadre support inferieur avec traverses metalliques anti-affaissement  
• 2 sacs à linge polyester inclus

- DE** • Stabile untere Ablage aus Metallstreben  
• Inkl. 2 grauen Polyestersäcken

- EN** • Lower PVC straps support  
• Including grey polyester bag

- IT** • Cinghie inferiori in PVC di supporto  
• Include un sacco poliestere grigio

- FR** • Support inférieur en sangles en PVC  
• Inclut un sac en polyester gris

- DE** • Stabile untere Ablage  
• Inkl. grauem Polyestersack

<b>IBIZA TRISAC 2</b>	2 x 127 Ltr.	4 swivel x Ø 125 mm with donut bumpers	Steel tube with grey powder coating RAL 9006 Struttura in tubo d'acciaio verniciato color grigio RAL 9006 Structure en tube d'acier peint gris clair RAL9006 Vierkant-Stahlrohr, pulverbeschichtet in RAL 9006 (grau)	755.6x 465x h1062.5 mm	12 Kg	060502IB
<b>CADDIE X</b>	150 Ltr.	4 swivel x Ø 125 mm, with donut bumper 2 of which with brake	Steel tube with grey powder coating RAL 9006 Struttura in tubo d'acciaio verniciato color grigio RAL 9006 Structure en tubes d'acier peint gris clair RAL9006 Stahlrohr, pulverbeschichtet RAL 9006	500x 485x h1050 mm	6,5 Kg	060101LN

## CADDIE X ECO

**NEW**



CADDIE X ECO

- EN** • Lower platform in folding wire  
• Including cotton bag

- FR** • Support inférieur anti-affaissement en fils d'acier  
• Inclut un sac à linge en coton

## CADDIE X EASY

**NEW**



CADDIE X EASY

- IT** • Piattaforma inferiore in filo pieghevole  
• Include un sacco cotone sanforizzato

- DE** • Stabile untere Ablage  
• Inkl. grauem Baumwollsack

<b>CADDIE X ECO</b>	230 Ltr.	4 swivel x Ø80 mm with donut bumper	Stainless steel Acciaio inox Acier inoxydable Edelstahl	530x 500x h1040 mm	6,5 Kg	CAD00227
<b>CADDIE X EASY</b>	230 Ltr.	4 swivel x Ø80 mm with donut bumper	Chromed steel Acciaio cromato Acier chromé Stahlrohr verchromt	530x 500x h1040 mm	6,5 Kg	CAD00239



# TRISAC 1 / 2 / 3



TRISAC 1



TRISAC 3

- EN**
- Lower platform with metal bars
  - 1, 2 or 3 detachable polyester bags
  - Black plastic lid for each laundry bag

- IT**
- Piattaforma inferiore con barre di metallo
  - 1, 2 o 3 sacchi in poliestere amovibili
  - Coperchio nero in plastica per ogni sacco

- FR**
- Structure support inférieure avec traverses métalliques anti-affaissement
  - 1, 2 ou 3 sacs polyester amovibles inclus
  - Couvercle en plastique noir pour chaque sac

- DE**
- Stabile untere Ablage aus Metallstreben
  - 1, 2 oder 3 abnehmbare Polyestersäcke
  - Schwarze Plastikdeckel

<b>TRISAC 1</b>	<b>BIGGER BAG</b> 127 Ltr.	4 swivel x Ø125 mm with donut bumpers, 2 of which with brake	Steel tube with grey powder coating RAL 9006 Struttura in tubo d'acciaio verniciato color grigio RAL 9006 Structure en tube d'acier peint gris clair RAL9006 Stahlrohr, pulverbeschichtet RAL 9006	426x 465x h1077,5 mm	9 Kg	060201LN
<b>TRISAC 2</b>	<b>BIGGER BAGS</b> 2 x 127 Ltr.			756x 465x h1077,5 mm	12 Kg	060202LN
<b>TRISAC 3</b>	<b>BIGGER BAGS</b> 3 x 127 Ltr.			1036x 465x h1077,5 mm	15 Kg	060203LN



TRISAC ALU 1



TRISAC ALU 3

- EN**
- White ABS bottom base
  - 1, 2, 3 or 4 moduls with detachable, anthracite polyester bags
  - Bracket clip for an easy fixation of the bags
  - Colored plastic lid for each laundry bag

- IT**
- Base bianca in ABS
  - Da 1 a 4 moduli con sacco amovibile grigio in poliestere
  - Clip per un comodo fissaggio dei sacchi
  - Coperchio in plastica colorata per ogni sacco

- FR**
- Base blanche en ABS
  - 1, 2, 3 ou 4 sacs polyester anthracite
  - Mise en place des sacs grâce à la fixation par anneau extérieur
  - Couvercle en plastique teinté pour chaque sac

- DE**
- ABS-Bodenplatte weiß lackiert
  - Inkl. 1, 2, 3 oder 4 abnehmbaren, grauen Polyestersäcken
  - Leichte Fixierung der Säcke durch Klemmbügel
  - Farbige Kunststoffdeckel

<b>TRISAC ALU 1</b>	87 Ltr.	4 swivel x Ø75 mm 'CMM', 2 of which with brake	Anodized aluminium tube frame, white ABS steel bottom base Struttura in tubo d'alluminio anodizzato con base bianca in ABS Structure en alliage léger anodisé, base en ABS Eloxiertes Aluminium, Bodenplatte aus Stahlblech weiß lackiert	390x 410x h880 mm	9 Kg	060301LN
<b>TRISAC ALU 2</b>	2 x 87 Ltr.			790x 410x h880 mm	16 Kg	060302LN
<b>TRISAC ALU 3</b>	3 x 87 Ltr.			1190x 410x h880 mm	19 Kg	060303LN
<b>TRISAC ALU 4</b>	4 x 87 Ltr.			1575x 410x h880 mm	23 Kg	060304LN



# SIRIO / SIRIO ERGO / CESTO



SIRIO



SIRIO ERGO



CESTO

- EN** • Elevated bottom (Sirio Ergo)  
• Stackable

- IT** • Base rialzata (Sirio Ergo)  
• Impilabile

- FR** • Fond relevé pour une meilleure ergonomie (Sirio Ergo)  
• Empilable

- DE** • Erhöhte, stabile Basis (Sirio Ergo)  
• Stapelbar

## Options



Options only available for the products marked with '\*'  
 Optional disponibile solo per i prodotti segnati con '\*'  
 Options seulement disponibles pour les produits désignés par '\*'  
 Optionen nur für die mit \* markierten Modelle

<b>SIRIO *</b>		4 swivel x Ø100 mm 'CMM'	Steel wire structure electrolytically galvanized with white powder coating Struttura in tubo d'acciaio elettro galvanizzata con verniciatura bianca	840x 630x h750 mm		14 Kg	99405750
<b>SIRIO ERGO *</b>	max. 250 Kg		Structure en fils d'acier soudée avec revêtement epoxy blanc anti-corrosion Verzinkter Drahtwagen, weiß pulverbeschichtet	840x 630x h1010 mm	270 Ltr.	22 Kg	99406750
<b>CESTO</b>	max. 400 Kg	4 swivel x Ø125 mm 'CMM'	Steel tube frame with wire mesh, electrolytically galvanized Struttura in tubo e filo d'acciaio. Finitura: zincatura brillante Tubes et fils d'acier, finition électro galvanisée Rohr- und Drahtkonstruktion, elektrolytisch verzinkt	810x 610x h740 mm		17,5 Kg	CEST001



## BACTAINER ALU / S/L



BACTAINER ALU S/L



BACTAINER ALU









- EN**
- Upper rim reinforced
  - Water-tight bottom plate
  - Perforated and removable double base with integrated drain tap (ALU)
  - Mobile spring driven self-leveling base that moves according to the weight (ALU S/L)

- FR**
- Bord supérieur arrondi et renforcé rond étanche
  - Grille de fond amovible perforée et bonde de vidange (ALU)
  - Fond mobile à niveau constant monté sur ressort (ALU S/L)

- IT**
- Bordo superiore rinforzato
  - Base inferiore a tenuta stagna
  - Doppio fondo forato e rimovibile con tappo di scarico (ALU)
  - Fondo mobile montato su molle che si regolano in base al peso caricato (ALU S/L)

- DE**
- Oberer Rand verstärkt
  - Wasserdichter Boden
  - Gelöcherter und abnehmbarer Doppelboden (ALU)
  - Integrierter Ablaufhahn (ALU)
  - Mobiler Federboden, der sich je nach Belastung senkt oder hebt für leichteres Be- und Entladen (ALU S/L)

							
<b>BACTAINER ALU S/L</b>	max. 70 Kg	2 swivel and 2 fixed x Ø125 mm	Anodized aluminium Struttura in alluminio anodizzato	1080x 630x 800 mm	336 Ltr.	51 Kg	070201AL
<b>BACTAINER ALU</b>	max. 150 kg	2 swivel and 2 fixed x Ø200 mm	Aluminium anodisé Eloxiertes Aluminium	1030x 630x h735 mm	270 Ltr.	32 Kg	070202AL



## BACTAINER 180 L

## BACTAINER 360 L



BACTAINER 180 L









BACTAINER 360 L

- EN**
- Removable lid with 2 foldable flaps
  - Integrated drain tap (3/4 inch)
  - Stackable

- IT**
- Coperchio amovibile con 2 alette pieghevoli
  - Tappo per lo scarico incluso
  - Impilabile

- FR**
- Couvercle amovible et articulé sur une charnière inox
  - Bonde de vidange
  - Empilable

- DE**
- Abnehmbarer Deckel mit 1/2 Öffnung
  - Mit integriertem Ablaufhahn (3/4 Zoll)
  - Stapelbar

							
<b>BACTAINER 180 L</b>	max. 200 kg	2 swivel and 2 fixed x Ø100 mm	White polypropylene Polipropilene bianco Polypropylène blanc	600x 440x h690 mm	180 Ltr.	15 Kg	070101PE
<b>BACTAINER 360 L</b>	max. 400 kg	2 swivel and 2 fixed x Ø150 mm	Polypropylen weiß, lebensmittelecht	950x570x h820 m	360 Ltr.	34 kg	070102PE

## MOBILINGE



MOBILINGE

- EN** • Blue plastic roll down curtain with velcro fasteners  
• 2 shelves, folding down at 90° angle for multipurpose use

- IT** • Telo di chiusura in plastica blu con fascette in velcro  
• 2 ripiani ribaltabili a 90°

- FR** • Rideau déroulant bleu en plastique avec fermeture vélcro  
• 1 étagère relevable et 1 rabattable à 90° pour usage polyvalent

- DE** • Blaue Verschlussabdeckung aus Kunststoff mit Klettverschluss  
• 2 Einlegeböden um 90° abklappbar für leichtes Handling

						
<b>MOBILINGE</b>	max. 135 Kg	2 swivel and 2 fixed x Ø125 mm	Anodized aluminium Struttura in lega leggera ossidata anodicamente Aluminium anodisé Eloxiertes Aluminium	800x 600x h1650 mm	48 Kg	070203AL





MOBILINGE M







MOBILINGE L

- EN**
- Non-marking and full wrap-around rubber bumper
  - 2 removable shelves
  - 2 doors with magnetic latches opening at 270°
  - Pushing handle

- IT**
- Paracolpo integrale anti-traccia
  - 2 ripiani interni regolabili in altezza
  - 2 porte con chiusura magnetica ed apertura a 270°
  - Maniglione di spinta

- FR**
- Pare-chocs périmétrique non marquant
  - 2 étagères amovibles
  - 2 portes ouvrant à 270° avec poignées verrous
  - Poignée de poussée

- DE**
- Nicht abfärbender, rundum Gummistoßschutz
  - 2 herausnehmbare Regale
  - 2 Türen mit seitlicher Magnethaftung, Öffnungswinkel 270°
  - Mit Schiebegriff

						
<b>MOBILINGE M</b>	max. 250 Kg	2 swivel and 2 fixed x Ø200 mm	Anodized aluminium Struttura in lega leggera ossidata anodicamente	1230x 630x h1500 mm	66 Kg	070204AL
<b>MOBILINGE L</b>			Aluminium anodisé Eloxiertes Aluminium	1230x 630x h1740 mm	70 Kg	070205AL

## TRANSLINGE



- EN**
- 2 wood laminated shelves folding down at 90°
  - Fixed base in white laminated wood
  - 4 front door panels on composite rust proof hinges
  - Corner bumpers

- IT**
- 2 ripiani in legno laminato ribaltabili a 90°
  - Base fissa in legno laminato bianco
  - 4 mezze porte con cerniere resistenti alla ruggine
  - Paracolpi angolari

- FR**
- 2 étagères plates relevables à 90° en bois mélaminé
  - Etagère de fond fixe en bois mélaminé
  - 2x2 demies portes sur charnières composites
  - Pare-chocs d'angle

- DE**
- Rollcontainer weiß pulverbeschichtet
  - Bodenetage weiß laminiert, fest montiert
  - Front mit 4 separat zu öffnenden Vierteltüren, Kunststoffscharniere
  - Eckstoßschutz

## Options



<b>TRANSLINGE</b>	max. 300 Kg	2 swivel and 2 fixed x Ø125 mm	Square steel tube frame with wire mesh panels, with a white powder coating Struttura in tubo e filo d'acciaio con base in lamiera verniciata bianco. Structure en tubes en fils d'acier, revêtement peint anti-corrosion blanc Vierkanthohrrahmen mit Drahtmaschung, weiß pulverbeschichtet	810x 560x h1850 mm	58 Kg	99402050



# ROLL LINGE EASY / EASY 3 / FLIP FRONT



ROLL LINGE EASY



ROLL LINGE EASY 3



ROLL LINGE FLIP FRONT

- EN**
- 2 (EASY) or 3 removable sides panels (EASY 3) including with 2 hooks and labeling space (EASY / EASY 3)
  - 2 fixed side panels, 1 fixed rear panel and 1 fixed lower front panel (FLIP FRONT)
  - Upper front panel foldable downwards at 180° (FLIP FRONT)
  - Mesh dimensions: 35x155 mm (base), 155x290 mm (sides)
- FR**
- 2 (EASY) / ou 3 panneaux démontables (EASY 3) avec 2 crochets et 2 plaques d'identification (EASY / EASY 3)
  - 2 panneaux latéraux fixes, 1 panneau arrière fixe et 1 demi-panneau avant inférieur fixe (FLIP FRONT)
  - Demi-panneau avant supérieur basculant à 180° (FLIP FRONT)
  - Maille: 35x155 mm (socle) / 155x290 mm (panneaux latéraux)
- IT**
- Roll container a due lati (EASY) o tre lati (EASY 3), con pannelli laterali amovibili, con 2 ganci e placca portatichette (EASY / EASY 3)
  - 2 pannelli laterali fissi, 1 pannello fisso posteriore e 1 mezzo pannello inferiore frontale fisso (FLIP FRONT)
  - Mezzo pannello frontale superiore ribaltabile 180° (FLIP FRONT)
  - Dimensioni maglia: 35x155 mm (base) , 155x290mm (pannelli)
- DE**
- Rollcontainer mit 2 Seiten (EASY) / mit 3 geschlossenen Seiten (EASY 3) / mit 3 Seiten und abklappbarer Fronttür 180° (FLIP FRONT)
  - Basis-/Seitenmaschenweite: 35x155 mm / 155x290 mm

## Options



<b>ROLL LINGE EASY</b>	max. 500 Kg	2 swivel and 2 fixed x Ø125 mm	Steel tube frame with wire mesh, electrolytically galvanized Struttura in tubo e filo d'acciaio. Finitura: zincatura brillante Tubes et fils d'acier, finition électro-galvanisée Rohr- und Drahtkonstruktion, elektrolytisch verzinkt	720x 750x h1700 mm	28 Kg	Disassembled product Prodotto smontato Produit démonté Demontiertes Produkt	
<b>ROLL LINGE EASY 3</b>					38 Kg		
<b>ROLL LINGE FLIP FRONT</b>				45 Kg	720x 810x h1700 mm		

# ROLL BASE / 3 / 4

**NEW**



ROLL BASE

**NEW**



ROLL BASE 3

**NEW**



ROLL BASE 4

- EN** • 2 (BASE) or 3 removable sides panels (BASE 3/4) including a labeling space  
 • Mesh dimensions: 45x180 mm (base); 106x405 mm (side)
- IT** • Roll container a due (BASE) o a tre lati (BASE 3/4) con pannelli laterali amovibili, include placca porta-etichette  
 • Dimensioni maglia: 45x180 mm (base) / 106x405 mm (pannello)

- FR** • 2 (BASE) ou 3 panneaux démontables (BASE 3/4) avec plaque d'identification  
 • Maille : 45x180 mm (socle) / 106x405 mm (panneaux latéraux)
- DE** • Rollcontainer mit 2 Seiten (BASE) / mit 3 geschlossenen Seiten (BASE 3/4) und abklappbarer Fronttür (BASE 4)  
 • Seitenteile herausnehmbar 2 Seitenwände mit Beschriftungsplatte  
 • Basis-/Seitenmaschenweite: 45x180 mm / 106x405 mm

## Options

R1

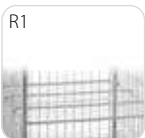

COV



<b>ROLL BASE</b>	max. 500 Kg	2 swivel and 2 fixed x Ø125 mm	Steel tube frame with wire mesh, electrolytically galvanized Struttura in tubo e filo d'acciaio. Finitura: zincatura brillante Tubes et fils d'acier, finition électro-galvanisée Rohr- und Drahtkonstruktion, elektrolytisch verzinkt	715x 805x h1800 mm	22 Kg	Disassembled product Prodotto smontato Produit démonté Demontiertes Produkt	ROLL001
<b>ROLL BASE 3</b>					27 Kg		ROLL002
<b>ROLL BASE 4</b>					34,5 Kg		ROLL003





ROLL LINGE SECURITY 10 + OPTION ET



ROLL LINGE SECURITY 250

- EN**
- Top panel
  - Doors can be padlocked (not included)
  - 1 full-height door opening at 270° (10)
  - 2 half doors opening at 270° (250)
  - Mesh dimensions: 35x150 mm (base) / 50x100 mm (side)







- IT**
- Pannello superiore
  - Possibilità di chiusura porte con lucchetto (non incluso)
  - 1 porta con apertura a 270° (10)
  - 2 mezze porte con apertura a 270° (250)
  - Dimensioni maglia: 35x150 mm (base) / 50x100 mm (pannelli laterali)

- FR**
- Couverture supérieure
  - Porte/s verrouillable/s avec cadenas (non-fourni)
  - 1 grande porte s'ouvrant à 270° (10)
  - 2 demies-portes s'ouvrant à 270° (250)
  - Maille: 35x150 mm (socle) / 50x100 mm (panneaux latéraux)

- DE**
- Komplett geschlossener Rollcontainer mit Deckel
  - Abschließbare Tür/en für Vorhängeschloss geeignet (Schloss nicht enthalten)
  - 1 große Tür, Öffnungswinkel 270° (10)
  - Horizontal geteilte Tür, Öffnungswinkel 270° (250)
  - Basis-/Seitenmaschenweite: 35x150 mm / 50x100 mm

## Options



							
<b>ROLL LINGE SECURITY 10</b>	max. 500 Kg	2 swivel and 2 fixed x Ø125 mm	Steel tube frame with wire mesh, electrolytically galvanized Struttura in tubo e filo d'acciaio. Finitura: zincatura brillante	720x 750x h1700 mm	47 Kg	Disassembled product Prodotto smontato Produit démonté	070303ZQ
<b>ROLL LINGE SECURITY 250</b>			Tubes et fils d'acier, finition électro-galvanisée Rohr- und Drahtkonstruktion, elektrolytisch verzinkt				070304ZQ



# ROLL SICUREZZA 1 / 2

**NEW**

**NEW**



ROLL SICUREZZA 1



ROLL SICUREZZA 2

- EN**
- Top panel
  - Door/s can be padlocked (not included)
  - 1 full-height door opening at 270° (1)
  - 2 half doors opening at 270° (2)
  - Mesh dimensions: 45x180 mm (base); 50x50mm (side)

- IT**
- Pannello superiore
  - Possibilità di chiusura porte con lucchetto (non incluso)
  - 1 porta con apertura a 270° (1)
  - 2 mezze porte con apertura a 270° (2)
  - Dimensioni maglia: 45x180 mm (base) / 50x50 mm (pannelli laterali)

- FR**
- Panneau de fermeture supérieur
  - Porte/s verrouillable/s avec cadenas (non-fourni)
  - 1 grande porte s'ouvrant à 270° (1)
  - 2 demies-portes s'ouvrant à 270° (2)
  - Maille: 45x180 mm (socle) / 50x50 mm (panneaux latéraux)

- DE**
- Komplett geschlossener Rollcontainer mit Deckel
  - Abschließbare Tür/en für Vorhängeschloss geeignet (Schloss nicht enthalten)
  - 1 große Tür, Öffnungswinkel 270° (1)
  - Horizontal geteilte Tür, Öffnungswinkel 270° (2)
  - Basis-/Seitenmaschenweite: 45x180mm / 50x5 mm

**Options**



<b>ROLL SICUREZZA 1</b>	max. 500 Kg	2 swivel and 2 fixed x Ø125 mm	Steel tube frame with wire mesh, electrolytically galvanized Struttura in tubo e filo d'acciaio. Finitura: zincatura brillante Tubes et fils d'acier, finition électro-galvanisée Rohr- und Drahtkonstruktion, elektrolytisch verzinkt	700x 800x h1800 mm	45 Kg	Disassembled product Prodotto smontato Produit démonté Demontiertes Produkt	ROLLS11
<b>ROLL SICUREZZA 2</b>					46 Kg		ROLLS12



caddie



## STENDER Z



STENDER Z

## STENDER BASE Z









STENDER BASE Z

- EN** • Bilateral extension bars (Z)  
 • Holds 30-35 garments on hangers  
 • Nestable

- IT** • Barre estendibili su entrambi i lati (Z)  
 • Possibilità di appendere fino a 30 - 35 capi  
 • Impilabile

- FR** • 2 extensions latérales (Z)  
 • Capacité 30 -35 cintres  
 • Emboîtable

- DE** • Beidseitige Ausziehelemente an oberem Holm (Z)  
 • Platz für ca. 30 -35 Jacken auf Bügeln  
 • Platzsparend ineinanderschiebbar

						
<b>STENDER Z</b>	80 Kg	4 swivel x Ø125 mm with donut bumpers, 2 of which with brake	Steel tube frame, lower part powder coated Telaio in tubo d'acciaio verniciato con parte superiore cromata Bâti en tube acier peinture.	1382/1880x 600x h1745 mm	13 Kg	040203CR
<b>STENDER BASE Z</b>	70 Kg	4 swivel x Ø80 mm with donut bumpers, 2 of which with brake	Structure en tubes d'acier verni, partie supérieure chromée Fahrgestell aus Stahl mit grauer Pulverbeschichtung, Kleiderstange verchromt	1140x 600x h1150 mm	11 Kg	STENBAZ 

## STENDER EASY



STENDER EASY

## STENDER EASY HR







STENDER EASY HR

- EN**
- Bilateral extension bars (EASY)
  - Holds 30 - 35 garments on hangers (EASY)
  - Removable structure (HR)
  - Available with optional hat rack (HR)

- FR**
- 2 extensions latérales (EASY)
  - Capacité 30 - 35 cintres (EASY)
  - Structure amovible (HR)
  - Disponible avec porte-chapeau (HR)

- IT**
- Barre estendibili su entrambi i lati (EASY)
  - Possibilità di appendere fino a 30 - 35 capi (EASY)
  - Struttura smontabile (HR)
  - Disponibile anche con l'opzione cappelliera (HR)

- DE**
- Beidseitige Ausziehelemente an oberem Holm (EASY)
  - Platz für ca. 30 - 35 Jacken auf Bügeln (EASY)
  - Mit Hutablage (HR)
  - Abnehmbare Struktur (HR)

					
<b>STENDER EASY</b>		4 swivel x Ø80 mm	Steel with chrome finish Tubo d'acciaio cromato Tubes acier chromé Stahlrohr verchromt	1549/2001x 557x h1562 mm	040201CR
<b>STENDER EASY HR</b>	80 Kg	4 swivel x Ø45 mm		1500x 550x h1720 mm	040202CR





# ROOM SERVICE

**EN As practical as beautiful:** our range for the specific needs of a perfect room-service delivery includes room-service tables, minibar trolleys and service carts.

**IT Tanto pratico quanto elegante:** la nostra gamma di prodotti per un perfetto servizio in camera comprende tavolini, carrelli rifornimento minibar e carrelli di servizio.

**FR Aussi pratique qu'élégant:** notre gamme de produits pour un room service parfait inclut des tables, des chariots de réapprovisionnement de minibar ainsi que des chariots de service en chambre.

**DE Praktisch und funktionell geht auch formschön:** zu unserem Programm für die spezifischen Anforderungen an einen perfekten Roomservice zählen stilvolle Serviertische, Minibar- sowie Servierwagen.



1

**Trendie bar**

EN Turn-down service bag with removable drawer.

IT Borsa per il servizio in camera con cassetto estraibile.

FR Sac de service en chambre avec tiroir amovible.

DE Zimmerservice-Tasche mit herausnehmbarer Schublade.

+

2

**Handie bar**

EN Room service trolley with waterproof pockets and perforated foam bottle holders.

IT Carrello per servizio in camera con tasche impermeabili e portabottiglie in schiuma perforata.

FR Chariot mini bar avec poches étanches et porte-bouteilles en mousse perforée.

DE Kompakter Zimmer-und Barservicewagen mit vielen wasserdichten Taschen sowie Schubladen mit einem extra Schaumstoff-Einsatz für Flaschen.

=

3

**Buddie bar**

EN A complete set of 2 separate elements brought together for an impeccable and efficient invisible room and bar service.

IT Carrello composto di 2 separati elementi riuniti per un servizio in camera e bar invisibile ed efficiente.

FR Un ensemble comprenant le TRENDIE et le HANDIE, réunis pour un service mini bar efficace et invisible.

DE Die Kombination aus 2 separaten Elementen sorgt für ein unsichtbares und gleichzeitig effizientes House-Keeping.

**The caddiebar**

1



3



- EN 1** Removable and washable inner plastic waste-pocket for excellent hygiene
- 2** Rigid plastic drawer with inner adjustable velcro dividers, keeping amenities and items well organized. Dividers can be removed and the Caddie can be washed and rinsed with water.
- 3** Rigid support with perforated foam.

- IT 1** Tasca interna in plastica portarifiuti rimovibile e lavabile per un'igiene senza impeccabile.
- 2** Cassetti con divisori interni regolabili in velcro che possono essere rimossi e il carrello può essere lavato e sciacquato con acqua.
- 3** Supporto rigido con schiuma perforata.

- FR 1** Poche-poubelle intérieure en plastique amovible et lavable pour une excellente hygiène.
- 2** Casier en plastique rigide avec séparateurs en velcro réglables. Les séparateurs sont amovibles et lavables à l'eau.
- 3** Support en mousse perforée. La mousse ne peut pas être retirée.

- DE 1** Absolut hygienisch: Viele Taschen und Innenelemente sind herausnehmbar und komplett waschbar. Mit Aufsteckband zum Fixieren am Handie.
- 2** Die festen Schubladen sind komplett entnehmbar. Sie verfügen über ein Trennwandsystem auf Klettverschlussbasis, das abnehmbar sowie waschbar ist.
- 3** Schaumstoff-Einsatz mit Flaschenaussparung.



### Available colours



RE - Red



BR - Brown



BL - Blue



BK - Black



RAL 15 pieces MOQ.

XX=\*CODE COLOR  
 COD. COLORE  
 CODE COULEUR  
 FARB CODE

<b>TRENDIE bar</b>	max. 10/15 Kg	-	PVCP (Hydrorepellent PVC-coated Polyester 600)	450x 380x h270 mm	4 Kg	CAD00083XX*
<b>HANDIE bar</b>	max. 25/30 Kg	2 x Ø 110 mm 2 x Ø 50 mm	PVCP (poliestere 600 idrorepellente rivestito in PVC)	450x 380x h620 mm	10 Kg	CAD00084XX*
<b>BUDDIE bar</b>	max. 35/45 Kg	2 x Ø 110 mm 2 x Ø 50 mm	Wasserdichtes PVC-beschichtetes Polyester 600	450x 380x h890 mm	14 Kg	CAD00085XX*





**EN** B-PALACE is the minibar solution from our Signature Serie. It brings a new dimension in terms of design and available finishes. Special feature, is the totally customizable inside set-up.

**FR** B-PALACE est la solution d'approvisionnement des minibars par Signature Serie. Il propose une nouvelle dimension en matière d'aspect et de finitions disponibles. Son équipement intérieur est configurable.

**IT** B-PALACE è la soluzione minibar della linea Signature Serie. Con i carrelli di questa linea viene introdotta una nuova idea in termini di design e finiture disponibili che permettono di personalizzare il carrello in base alle proprie esigenze.

**DE** B-PALACE komplettiert als Minibar-Servicewagen das Angebot der Signature Serie. Auch hier stehen Individualität in der Innenraumgestaltung sowie bei der äußeren Aufmachung im Vordergrund.

**Options**



<b>B-PALACE</b>	max. 150 Kg	4 swivel x Ø160 mm + RS5	Laminated wood structure Struttura in legno laminato Bois mélaminé Melaminharzbeschichtetes Holz	850x 535x h1270 mm	70 Kg	050103





- EN**
- 1** Laminated wood structure with eco leather cover
  - 2** Full range of leather and textile materials for the outer panels as well as matching handles, locks and castors. Personalized finishes for metal parts.
  - 3** 3 inner drawers with compartments
  - 4** 1 shelf
  - 5** Small items box with lockable lid
  - 6** Lockable doors
  - 7** Standard 5th wheel

- IT**
- 1** Struttura in legno laminato con rivestimento in eco pelle
  - 2** Intera gamma in ecopelle e tessuto per il rivestimento esterno. Maniglie in coordinato e parti di metallo personalizzabili
  - 3** 3 cassetti interni con separatori
  - 4** 1 ripiano
  - 5** Scompartimento superiore con coperchio e serratura
  - 6** Chiusura porte con chiave
  - 7** RS5 di serie

- FR**
- 1** Structure en bois mélaminé recouverte de cuir
  - 2** Palette complète de cuirs et de matériaux texturés ou lisses pour la finition extérieure. Poignées et serrures assorties.
  - 3** 3 tiroirs intérieurs avec compartiments
  - 4** 1 étagère
  - 5** Cavité supérieure avec couvercle métallique
  - 6** Kit de portes verouillables
  - 7** 5ème roue centrale

- DE**
- 1** Korpus aus laminiertem Holz ist aus leder verkleidet
  - 2** Große Auswahl an Oberflächen wie Leder- oder Stoffbezüge, Griffe und Schlösser
  - 3** 3 innenliegende Schubladen mit Trennstegen
  - 4** 1 Etage
  - 5** Kleinartikelkasten mit abschließbarem Deckel
  - 6** Abschließbare Flügeltüren
  - 7** 5te Rolle 'RS5' zur besseren Manövrierbarkeit im beladenen Zustand



IBIZA BAR M

- EN**
- 3 shelves with metal retaining bars, 2 of which height-adjustable
  - 1 metal drawer with separators made of HPL (2 pcs. for M, 3 pcs. for L) maximum storage height 13,5 cm
  - Non marking and full wrap-around rubber bumper

- FR**
- 3 étagères avec barres métalliques de retenue dont ajustables
  - 1 tiroir en métal avec séparateurs ajustables HPL (taille M: 2, taille L: 3). Hauteur maximale de stockage : 13.5 cm
  - Pare-chocs intégral non marquant

- IT**
- 3 ripiani con spondine di protezione, di cui 2 regolabili in altezza
  - 1 cassetto in metallo con separatori in HPL (mod. M= 2 pz., mod. L= 3pz), altezza massima di stoccaggio 13.5 cm
  - Bordo paracolpo in gomma antitraccia

- DE**
- 3 Ebenen mit Schutzreling, davon 2 höhenverstellbar
  - 1 Metallschublade mit variabler Inneneinteilung aus HPL (M= 2 Stk., L= 3 Stk.), max. Höhe 13,5 cm
  - Oberste Ebene mit Aufkantung als Abrutschschutz
  - Nicht abfärbender rundum Gummistoßschutz

## Options



## Panel Finish



<b>IBIZA BAR M</b>	max. 150 Kg	4 swivel x Ø150 mm 'CMP'	Steel tubing structure with HPL panels Struttura in tubo verniciato con pannelli HPL	890x 566x h1333 mm	40 Kg	080503HPL
<b>IBIZA BAR L</b>			Structure en tubes d'acier avec panneaux en HPL Stahlrohrrahmen grau pulverbeschichtet, HPL-Platten	1096x 566x h1333 mm	46 Kg	080504HPL

## BORA-BORA M / L



BORA-BORA L

- EN**
- Non marking and full wrap-around rubber bumper
  - 3 metal drawers with separators made of HPL (2 pcs. for M, 3 pcs. for L); storage height: top 24 cm, middle 27 cm, bottom 27 cm
  - Standard 5th wheel

- IT**
- Bordo paracolpo in gomma antitraccia
  - 3 cassetti interni in metallo con separatori in HPL (mod. M= 2 pz., mod. L= 3 pz.): superiore 24 cm, centrale 27 cm, inferiore 27 cm
  - RS5 di serie

- FR**
- Pare-chocs intégral non-marquant
  - 3 tiroirs en métal avec séparateurs ajustables HPL (taille M: 2, taille L: 3); hauteur de stockage des tiroirs: haut 24 cm, milieu 27 cm, bas 27 cm
  - 5ème roue centrale







- DE**
- 3 Metallschubladen mit variabler Inneneinteilung aus HPL (M = 2 Stk., L = 3 Stk.); Stellhöhen in Schubladen: Oben 24 cm, Mitte 27 cm, Unten 27 cm
  - Nicht abfärbender rundum Gummistoßschutz
  - 5te Rolle 'RS5' zur besseren Manövrierbarkeit im beladenen Zustand

## Options



## Panel Finish



						
<b>BORA-BORA M</b>	max. 150 Kg	4 swivel x Ø150 mm 'CMP', 2 of which with brake + RS5	Steel tubing structure with HPL panels Struttura in tubo verniciato con pannelli HPL	890x 566x h1333 mm	54 Kg	080203HPL
<b>BORA-BORA L</b>			Structure en tubes d'acier avec panneaux en HPL Stahlrohrrahmen grau pulverbeschichtet, HPL-Platten	1096x 566x h1333 mm	60 Kg	080204HPL



# CHARLOTTE M / L



CHARLOTTE M + LID

**EN** • 3 metal drawers with separators; storage height: top 14 cm, middle 24 cm, bottom 28 cm, base shelf 30 cm  
 • With pushing handle

**IT** • 3 cassetti interni in metallo con separatori HPL: superiore 14 cm, centrale 24 cm, inferiore 28 cm, base carrello 30 cm  
 • Maniglione di spinta

**FR** • 3 tiroirs en métal avec séparateurs ajustables HPL. Hauteur des tiroirs: haut 14 cm, milieu 24 cm, bas 28 cm, étagère du bas 30 cm  
 • Poignée de poussée

**DE** • 3 Metallschubladen mit verstellbarer Inneneinteilung; Stellhöhen in Schubladen: Oben 14 cm, Mitte 24 cm, Unten 28 cm, Boden 30 cm  
 • Mit Schiebegriff

## Options



## Panel Finish

LAM

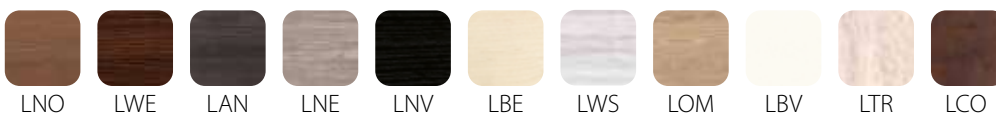

<b>CHARLOTTE M</b>	max. 150 Kg	4 swivel x Ø150 mm 'CMP', 2 of which with brake + RS5	Laminated wood structure Struttura in legno laminato Bois mélaminé Melaminharzbeschichtetes Holz	850x 535x h1270 mm	65 Kg	080103WD
<b>CHARLOTTE L</b>				1030x 535x h1270 mm	70 Kg	080104WD

## BALI BAR

NEW



- EN** • 4 metal drawers with separators; storage height: top 11.5 cm, middle 14.5 cm, middle 24.5 cm, bottom 31 cm
- 4 donut bumpers
  - Double pushing handle

- IT** • 4 cassetti interni in metallo con separatori HPL: superiore 11,5 cm, centrale 14,5 cm, centrale 24,5 cm, inferiore 31 cm
- 4 ruote paracolpo ricoperte di gomma antitraccia
  - Doppia maniglia di spinta

- FR** • 4 tiroirs en métal avec séparateurs ajustables HPL. Hauteur des tiroirs: haut 11,5 cm, milieu 14,5 cm, milieu 24,5 cm, bas 31 cm.
- 4 pare-chocs annulaires
  - 2 poignées de poussée

- DE** • 4 Metallschubladen mit verstellbarer Inneneinteilung; Stellhöhen in Schubladen: Oben 11.5 cm, Mitte 14.5 cm, Mitte 24.5 cm, Unten 31 cm
- Mit Schiebegriff

## Options



## Panel Finish

HPL



SFB









SOM



SWE



SNE

						
<b>BALI BAR</b>	max. 150 Kg	4 swivel x Ø150 mm 'CMP', 2 of which with brake + RS5	Steel tubing structure with HPL panels Struttura in tubo verniciato con pannelli HPL Structure en tubes d'acier avec panneaux en HPL Stahlrohrrahmen pulverbeschichtet, HPL-Platten	900x 590x h1290 mm	64 Kg	CAD00167



**NEW**



THELIVERIE + HOTBOX

- EN**
- 1 drawer with separators; storage height: top 14 cm
  - With pushing handle
  - 2 height adjustable shelves
  - Single door

- IT**
- 3 cassetti interni in metallo con separatori HPL: superiore 14 cm,
  - Maniglione di spinta
  - 2 ripani regolabili in altezza
  - Porta singola frontale

- FR**
- 1 tiroir en métal avec séparateurs ajustables HPL. Hauteur des tiroirs: haut 14 cm
  - Poignée de poussée
  - 2 étagères ajustables
  - Porte simple

- DE**
- 1 Metallschublade mit variabler Inneneinteilung aus HPL max. Höhe 14 cm
  - Mit Schiebegriff
  - 2 höhenverstellbare Einlegeböden
  - Einzeltür

**Options**



**Panel Finish**



<b>THELIVERIE</b>	max. 150 Kg	4 swivel castors Ø150 mm 'TPP', 2 with brakes	Laminated wood structure Struttura in legno laminato Bois mélaminé Melaminharzbeschichtetes Holz	630 x 535 x h1360 mm	Compatible only with HOT BOX and THERMOBOX	49 Kg	CAD00216

# TABLE EASY



TABLE EASY



TABLE EASY + HOT BOX



TABLE EASY









- EN** • Fits up to 2 HOT BOXes at the same time  
• Fold down side pages

- IT** • Adatto a trasportare fino a 2 HOT BOX  
• Flaps laterali pieghevoli

- FR** • Compatible avec 2 HOT BOX  
• Côtés rabattables

- DE** • Verchromtes Untergestell für den Transport von bis zu 2 HOT BOXen gleichzeitig  
• Abklappbare Seitenteile



						
<b>TABLE EASY</b>	4 swivel x Ø125 mm 'TPP'; 2 of which with brake	Solid CDF wood in graphite color finish, steel frame with chrome finish Top in legno CDF colore grafite, struttura in tubo cromato Bois CDF finition coloris anthracite, structure en tubes d'acier chromé CDF Holz in der Farbe graphit, verchromter Stahl	900/546x h770 mm	Compatible only with HOT BOX	16 Kg	090102

# TABLE COMPACT XS



TABLE COMPACT XS + HOT BOX



TABLE COMPACT XS + HOT BOX









TABLE COMPACT XS

- EN**
- Fits only 1 HOT BOX
  - Entire structure folds to save space while not in use to a total width of 33cm

- IT**
- Adatto a trasportare 1 HOT BOX
  - Struttura completamente pieghevole fino ad una profondità di 33 cm

- FR**
- Compatible avec 1 HOT BOX
  - Côtés rabattables
  - Plateau entièrement pliable (Très faible encombrement: 33 cm de largeur)

- DE**
- Verchromtes Untergestell für den Transport von 1 HOT BOX
  - 4-fach abklappbare Seitenteile
  - Gestell kompakt auf 33 cm Breite zusammenklappbar

						
<b>TABLE COMPACT XS</b>	4 swivel x Ø125 mm 'TPP'; 2 of which with brake	Solid CDF wood in graphite color finish, steel frame with chrome finish Top in legno CDF colore grafite, struttura in tubo cromato Bois CDF finition coloris anthracite, structure en tubes d'acier chromé CDF Holz in der Farbe graphit, verchromter Stahl	900/326x h980 mm	Compatible only with HOT BOX	18 Kg	090101



## TABLE FLIP TOP



TABLE FLIP TOP



TABLE FLIP TOP + 2 HOT BOX



TABLE FLIP TOP









- EN** • Fits up to 2 HOT BOXes at the same time  
• Whole table top flips vertically and can be stacked, saving space for nesting while not in use

- IT** • Adatto a trasportare fino a 2 HOT BOX  
• Piano ribaltabile verticalmente e impilabile quando non in uso

- FR** • Compatible avec 2 HOT BOX  
• Côtés rabattables, plateau basculant (faible encombrement)

- DE** • Verchromtes Untergestell für den Transport von bis zu 2 HOT BOXen gleichzeitig  
• Gesamte Tischplatte senkrecht abklapp- und arretierbar, daher platzsparend ineinander schiebbar



						
<b>TABLE FLIP TOP</b>	4 swivel x Ø125 x 125 mm 'TPP', 2 of which with brake	Solid CDF wood in graphite color finish, steel frame with chrome finish Top in legno CDF colore grafite, struttura in tubo cromato Bois CDF finition coloris anthracite, structure en tubes d'acier chromé CDF Holz in der Farbe graphit, verchromter Stahl	900/546x h786/1170 mm	Compatible only with HOT BOX	15 Kg	090103 



Compatible only with:  
TABLE FLIP TOP - TABLE EASY -  
TABLE COMPACT XS - BOX TAXI



- EN**
- Electrical heat box 500W made of stainless steel
  - Fully insulated structure
  - 2 height adjustable mesh shelves
  - Suitable for plates up to Ø32 cm





- IT**
- Box termico 500W in acciaio inox
  - Struttura completamente isolata
  - 2 griglie regolabili in altezza
  - Adatto a piatti fino a Ø32 cm

- FR**
- Caisson chauffant 500W en inox
  - Structure entièrement isolée
  - 2 étagères ajustables en fil d'acier
  - Assiettes jusqu'à Ø32 cm

- DE**
- Elektrische Wärmebox 500W aus Edelstahl
  - Isolierte Wände
  - 2 höhenverstellbare Gittereinlegeböden
  - Für Teller bis Ø32 cm geeignet

### Options



						
	INTERNAL DIMENSIONS				KG	CODE
<b>HOT BOX</b>	For plates up to Ø 32cm Per piatti fino a Ø 32cm Assiettes jusqu'à Ø32 cm Teller Ø bis 32 cm	Stainless steel Acciaio inox Acier inoxydable Edelstahl	405x 380x h512 mm	Compatible only with TABLE FLIP TOP TABLE EASY TABLE COMPACT XS BOX TAXI THELIVERIE	18 Kg	090200IN

## BOX TAXI



BOX TAXI



BOX TAXI + 6 HOT BOX

- EN**
- 2 levels for a total load capacity of 6 HOT BOXes
  - Cabling designed for either individual or simultaneous heating of HOT BOXes with just one power plug

- FR**
- Transport et charge jusqu'à 6 HOT BOX
  - Alimentation prévue pour une mise en température simultanée ou individuelle des HOT BOX avec une seule prise murale

- IT**
- 2 ripiani per una capacità di trasporto totale fino a 6 HOT BOX
  - Cablaggio adatto sia per riscaldamento singolo o simultaneo degli HOT BOX con una sola presa

- DE**
- 2 Etagen für bis zu 6 HOT BOXen
  - Separate Stromanschlüsse für jeden Stellplatz

## Options



<b>BOX TAXI</b>	max. 150 Kg	4 swivel x Ø125 mm "TPP" with donut bumpers, 2 of which with brake	Stainless steel Acciaio inox Acier inoxydable Edelstahl	1467x 562x h1363 mm	Compatible only with HOT BOX	30 Kg	0902011N



NEW



TABLE FLIP TOP ECO 80



TABLE FLIP TOP ECO 90 + HOT BOX ECO











TABLE FLIP TOP ECO 80

- EN**
- Fits up to 1 HOT BOX ECO
  - Whole table top flips vertically and can be stacked, saving space for nesting while not in use
  - Anti-scratch and non-slip shelf

- IT**
- Adatto a trasportare 1 HOT BOX ECO
  - Piano ribaltabile verticalmente e impilabile quando non in uso
  - Ripiano anti antigraffio ed antiscivolo

- FR**
- Compatible avec 1 HOT BOX ECO
  - Côtés rabattables, plateau basculant (faible encombrement)
  - Étagère anti-rayures et antidérapante

- DE**
- Verchromtes Untergestell für den Transport von bis zu 1 HOT BOX ECO
  - Gesamte Tischplatte senkrecht abklapp- und arretierbar, daher platzsparend ineinander schiebbar
  - Kratzfestes und rutschfestes Tischplatte

						
<b>TABLE FLIP TOP ECO 80</b>	4 swivel x Ø95 mm, 2 of which with brake	Solid MDF wood in black color finish, stainless steel frame Top in legno MDF colore nero, struttura in acciaio inox	800x h780 mm	Compatible only with HOT BOX ECO	15 Kg	CAD00221 
<b>TABLE FLIP TOP ECO 90</b>	4 swivel x Ø125 mm, 2 of which with brake	Bois MDF finition coloris noir, structure en tubes d'acier inoxydable MDF Holz in der Farbe schwarz, Edelstahlrohr matt	900x h780 mm		18 Kg	CAD00222 

## HOT BOX ECO

NEW



HOT BOX ECO

Compatible only with:  
TABLE FLIP TOP ECO 80 -  
TABLE FLIP TOP ECO 90 -  
BOX TAXI ECO

- EN**
- Electrical heat box 230V made of stainless steel
  - Fully insulated structure
  - PVC handle to transport the box
  - 2 height adjustable mesh shelves
  - Suitable for plates up to Ø32 cm

- IT**
- Box termico 230V in acciaio inox
  - Struttura completamente isolata
  - Maniglia in PVC per lo spostamento
  - 2 griglie regolabili in altezza
  - Adatto a piatti fino a Ø32 cm

- FR**
- Caisson chauffant 230V en inox
  - Structure entièrement isolée
  - Poignée en PVC pour la transporter
  - 2 étagères ajustables en fil d'acier
  - Assiettes jusqu'à Ø32 cm

- DE**
- Elektrische Wärmebox 230V aus Edelstahl
  - Isolierte Wände
  - PVC-Griff zum transportieren
  - 2 höhenverstellbare Gittereinlegeböden
  - Für Teller bis Ø32 cm geeignet

<b>HOT BOX ECO</b>	For plates up to Ø 32cm Per piatti fino a Ø 32cm Assiettes jusqu'à Ø32 cm Teller Ø bis 32 cm	Stainless steel Acciaio inox Acier inoxydable Edelstahl	450x 460x h510 mm	Compatible only with TABLE FLIP TOP ECO	12 Kg	400 W	CAD00224



NEW



BOX TAXI ECO + 6 HOT BOX ECO

- EN**
- 2 levels for a total load capacity of 6 HOT BOXes ECO
  - Cabling designed for either individual or simultaneous heating of HOT BOXes ECO with just one power plug

- IT**
- Due livelli per il trasporto fino a 6 HOT BOX ECO alla volta
  - Dotato di alimentatore per il riscaldamento simultaneo o individuale di HOT BOX ECO con una presa a parete singola

- FR**
- Transporte et charge jusqu'à 6 HOT BOX ECO
  - Alimentation prévue pour une mise en température simultanée ou individuelle des HOT BOX ECO avec une seule prise murale

- DE**
- 2 Etagen für bis zu 6 HOT BOXen ECO
  - Separate Stromanschlüsse für jeden Stellplatz

<b>BOX TAXI ECO</b>	max. 150 Kg	4 swivel x Ø125 mm with donut bumpers, 2 of which with brake	Stainless steel Acciaio inox Acier inoxydable Edelstahl	1530x 560x h1390 mm	Compatible only with HOT BOX ECO	25 Kg	2400 W	CAD00223

## PASSEPARTOUT 2

## PASSEPARTOUT 3



- EN**
- 2 or 3 tiers
  - Shelves with retaining bars in chrome finish
  - Side pushing bars

- IT**
- 2 o 3 ripiani
  - Ripiani con spondine di protezione cromate
  - Maniglioni di spinta

- FR**
- 2 ou 3 niveaux
  - Étagères avec barres de retention en finition chromée
  - Poignée de poussée

- DE**
- 2 bzw. 3 Etagen mit Schutzreling aus Edelstahl
  - Schiebegriff

## Panel Finish



PMB



PBE



PWE



Many other colors available with MOQ.  
Information in panel finish section.

<b>PASSEPARTOUT 2</b>	100 kg	4 swivel x Ø100 mm 'TPP' with donut bumper	Tube frame with chrome finish, laminated wood Struttura cromata, ripiani in legno laminato	980x 470x h945 mm	040102WD
<b>PASSEPARTOUT 3</b>	150 kg		Structure tubes acier chromé, bois mélaminé Edelstahl Rohrstruktur, melaminharzbeschichtetes Holz	980x 470x h945 mm	040103WD



## LUGGAGE RACK CR / S

## LUGGAGE RACK BR / S









- EN**
- Luggage rack with an universal design, perfect for every hotel
  - Model S with backrest for better support of the suitcase
  - Foldable

- IT**
- Reggivalige dal design universale, ideale per ogni hotel
  - Modello S provvisto di schienale per un sostegno migliore della valigia
  - Pieghevole

- FR**
- Porte-bagages au design universel, parfait pour chaque hôtel
  - Modèle S avec dossier pour un meilleur support de la valise
  - Pliable

- DE**
- Gepäckablage mit universellem Design, perfekt für jedes Hotel
  - Modell S mit Rückenlehne für besseren Halt des Koffers
  - Zusammenklappbar

						
<b>LUGGAGE RACK CR</b>	max. 60 Kg	Brushed chromed steel with PVC black belts, with backrest (S) Acciaio cromato con cinghie nere in PVC provvisto di schienale (S)	680x 430x h520 mm	Tubes diameter 25 mm Tubular thickness 0.8 mm	1,6 Kg	CAD00031
<b>LUGGAGE RACK CR S</b>		Tubes d'acier chromé et sangles en PVC noir, avec dossier (S) Chromstahl gebürstet, schwarze PVC-Gurte	680x 430x h715 mm		2,6 Kg	CAD00032
<b>LUGGAGE RACK BR</b>		Steel tube with brass finish with PVC black belts, with backrest (S) Acciaio con finitura ottonata con cinghie nere in PVC provvisto di schienale (S)	680x 430x h520 mm		1,6 Kg	CAD00033
<b>LUGGAGE RACK BR S</b>		Tubes d'acier finition laiton, sangles en PVC, noir, avec dossier (S) Stahl vermessingt, schwarze PVC-Gurte	680x 430x h715 mm		2,6 Kg	CAD00034



## LUGGAGE RACK W-MG / W-LNO / WS-LNO

NEW



LUGGAGE RACK W-MG

NEW



LUGGAGE RACK W-LNO

NEW



LUGGAGE RACK WS-LNO

- EN**
- Sturdy and attractive design
  - Easy clean up
  - Foldable
  - Easy one hand fold
  - Model S with backrest for better support of the suitcase

- IT**
- Design robusto e accattivante
  - Facile da pulire
  - Pieghevole
  - Si piega con una mano
  - Modello S provvisto di schienale per un sostegno migliore della valigia

- FR**
- Design robuste et attrayant
  - Facile à nettoyer
  - Pliable
  - Pliage facile d'une main
  - Modèle S avec dossier pour un meilleur support de la valise

- DE**
- Robustes und ansprechendes Design
  - Einfach aufzuräumen
  - Zusammenklappbar
  - Einfach mit einer Hand falten
  - Modell S mit Rückenlehne für besseren Halt des Koffers

<b>LUGGAGE RACK W-MG</b>	max. 50 Kg	Pine wood with Nylon black belts Struttura in legno di pino con cinghie nere in Nylon Pin et sangles en nylon Kiefernholz, schwarze Nylon-Gurte	450x 460x h620 mm	2 Kg	CAD00123
<b>LUGGAGE RACK W-LNO</b>		Dark walnut wood with Nylon black belts Struttura in legno di noce scuro con cinghie nere in Nylon Noyer foncé et sangles en nylon Kiefernholz, schwarze Nylon-Gurte	480x480x h530 mm		CAD00123. LNO
<b>LUGGAGE RACK WS-LNO</b>		480x480x h580 mm	CAD00213S. LNO		



## GEA



- EN** • 3 adjustable and removable vertical bars  
• Non-marking corner protection

- IT** • Dotato di 3 barre amovibili e regolabili  
• Paracolpi angolari in gomma

- FR** • 3 supports pour nappes réglables en hauteur et en profondeur  
• 4 pare-chocs d'angle

- DE** • 3 verstellbare und abnehmbare Querstreben  
• Nicht abfärbender

## VERSO R



- EN** • 1 garment rail  
• 3 foldable shelves with chrome finish  
• Full metal sheet bottom plate with powder coating  
• Non-marking corner protection

- IT** • 1 barra appendiabiti  
• 3 ripiani cromati amovibili e ribaltabili  
• Base in metallo verniciato  
• Paracolpi angolari







- FR** • 1 barre de penderie  
• 3 étagères relevables en fil d'acier chromé  
• Base pleine en métal avec revêtement gris  
• 4 pare-chocs d'angle

- DE** • 1 Kleiderstange  
• 3 abklappbare Drahtböden  
• Bodenplattform aus Stahl, pulverbeschichtet  
• Nicht abfärbender Kantenschutz

## Options



Options only available for the products marked with '\*'  
Optional disponibile solo per i prodotti segnati con '\*'  
Options seulement disponibles pour les produits désignés par '\*'  
Optionen nur für die mit \* markierten Modelle

						
<b>GEA</b>	Bars 10 Kg each Base 100 Kg	4 swivel x Ø 150 mm 'CMP', 2 of which with brake	Square steel tube frame with powder coating in RAL 9006 Struttura in metallo verniciato grigio chiaro RAL 9006	940x 620x h1851 mm	40 Kg	040301GR
<b>VERSO R*</b>	200 Kg		Tubes acier section carrée, peinture grise RAL 9006 Vierkant-Stahlrohr, pulverbeschichtet RAL 9006	940x 620x h1851 mm	40 Kg	040302GR









- EN**
- Refillable polish container, capacity 150 ml
  - Automatic switch on / switch off by shoes approaching sensor
  - Powering: 230V - 50 Hz
  - Soft base for footwear
  - Non-slip feet

- IT**
- Contenitore cera ricaricabile, capacità 150 ml
  - Attivazione / spegnimento automatici con sensore presenza scarpe
  - Alimentazione: 230 V - 50 Hz
  - Base d'appoggio della calzatura morbida
  - Piedi antiscivolo

- FR**
- Récipient cire rechargeable, capacité 150 ml
  - Activation et arrêt automatique grâce à un capteur de présence de chaussure
  - Alimentation: 230 V - 50 Hz
  - Base de support pour chaussures souples
  - Pieds antidérapants

- DE**
- Nachfüllbarer Farbbehälter, Kapazität 150 ml
  - Automatisches Ein- / Ausschalten durch Schuhannäherungssensor
  - Stromversorgung: 230 V - 50 Hz
  - Stützbasis für weiches Schuhwerk
  - Rutschfeste Füße

\* REVOLUTIONS PER MINUTE

						
<b>LUCY</b>	1200 rpm*	Stainless steel Acciaio inox Acier inoxydable Edelstahl	200x 370x h330 mm	100 W	6,2 Kg	CAD00091



NEW



- EN**
- Easily foldable
  - Wooden slats, light, easy to assemble
  - Mattress included
  - Swiveling wheels for easy transport
  - Mattress color subject to availability

- IT**
- Facile da richiudere quando non in uso
  - Doghe in legno, leggero, facile da montare
  - Materasso incluso
  - Ruote girevoli per facilitare il trasporto
  - Colore del materasso secondo disponibilità

- FR**
- Structure entièrement pliable
  - Lattes de bois, léger et facile à monter
  - Matelas inclus
  - Roues pivotantes pour un transport facile
  - Couleur du matelas selon disponibilité

- DE**
- Einfach klappbar
  - Kopteil, Bezug inklusive
  - Holz-Lattenrost, leicht
  - Schwenkräder für einfachen Transport
  - Matratzenfarbe je nach Verfügbarkeit

						
<b>FOLDIE ECO</b>	max. 150 Kg	Ø 40 mm	Steel tube frame Struttura in metallo Cadre renforcé Verstärkte Metallrahmenkonstruktion	800x 1840x h390 mm	12 Kg	CADBR01 

## BABY BED SLEEP'N PLAY



## BEDDIE ERGO S



NEW

- EN**
- Easily foldable
  - Corner protection (BABY BED)
  - Standard mattress 2 cm (thickness)
  - Side opening with zipper (BABY BED)
  - Portable with carry handle (BABY BED)
  - Internal dimensions: 90x60 cm (BEDDIE)

- FR**
- Cadre renforcé et moussé entièrement pliable
  - Protections angulaires (BABY BED)
  - Matelas standard épaisseur 2 cm
  - Côté ouvrant avec fermeture éclair (BABY BED)
  - Transportable avec poignée (BABY BED)
  - Dimensions intérieures: 90x60 cm (BEDDIE)

- IT**
- Facilmente richiudibile quando non in uso
  - Protezioni angolari
  - Materassino standard spesso 2 cm
  - Lato con apertura a zip
  - Sacca per riporlo comodamente quando non in uso
  - Dimensioni interne: 90x60 cm (BEDDIE)

- DE**
- Verstärkte Metallrahmenkonstruktion mit Klappmechanismus
  - Bunter Eckschutz (BABY BED)
  - 2 cm Flachmatratze (Standard)
  - Vordere Ausstiegsöffnung mit Reißverschluss (BABY BED)
  - Tasche zum praktischen Verstauen und Lagern bei Nichtgebrauch (BABY BED)
  - Innenmaße: 90x60 cm (BEDDIE)

## Options



Options only available for the products marked with '\*'  
 Optional disponibile solo per i prodotti segnati con '\*'  
 Options seulement disponibles pour les produits désignés par '\*'  
 Optionen nur für die mit \* markierten Modelle

						
<b>BABY BED SLEEP'N PLAY *</b>	max. 15 Kg	2 x Ø 100 mm	Steel tube frame Scheletro in metallo Cadre renforcé Verstärkte Metallrahmenkonstruktion	1250x 690x h850 mm	7,5 Kg	090300PL
<b>BEDDIE ERGO S</b>	max. 15 Kg	-	Pine wood Struttura in legno di pino Pin Kiefernholz	660x 1010x h960 mm	13 Kg	CAD00095S





# FOOD SERVICE

**EN Style & service:** functionality matches with style. We are constantly looking for new solutions to meet your standards and needs, providing you the best alternatives for a high level F&B service.

**IT Lo stile nel servire:** funzionalità senza dimenticare lo stile. Siamo sempre alla ricerca di soluzioni all'altezza delle vostre strutture, in grado di garantirvi un servizio F&B di alta qualità

**FR Style & service:** la fonctionnalité s'associe au style. Nous recherchons constamment de nouvelles solutions pour répondre aux besoins, tout en apportant un service F&B de qualité.

**DE Stil & Service:** funktionalität trifft Stil. Wir sind ständig auf der Suche nach neuen Lösungen, die Ihren Standards sowie Anforderungen entsprechen und Ihnen die besten Alternativen für einen erstklassigen F & B Service bieten.



## COFFIE



- EN**
- Lockable shutter
  - 2 height-adjustable shelves
  - Non marking and full wrap-around rubber bumper
  - 2 side folding shelves in steel with bumpers
- IT**
- Chiusura con serratura
  - 2 ripiani regolabili in altezza
  - Bordo paracolpo in gomma antitraccia
  - 2 ripiani pieghevoli laterali in acciaio con paraurti
- FR**
- Volet roulant verrouillable
  - 2 niveaux étagères ajustables
  - Pare-chocs intégral non-marquant
  - 2 étagères latérales rabattables en acier et pare-chocs annulaires d'angle non marquants
- DE**
- Abschließbarer Kunststoffrollo inkl. Schloss
  - 2 höhenverstellbare Einlegeböden
  - Abriebfester und umlaufender Gummistoßschutz mit Schutzreling
  - 2 seitliche Klappböden aus Stahl mit Abweisinge

### Options

RNYI \*



### Panel Finish for Coffie

HPL



SFB



SOM



SWE



SNE

## TRAY STAND W

**NEW**



TRAY NOT INCLUDED

- EN**
- Sturdy and attractive design
  - Easy clean up
  - Easy one-hand fold
- IT**
- Design robusto e accattivante
  - Facile da pulire
  - Si piega con una mano
- FR**
- Design robuste et attrayant
  - Facile à nettoyer
  - Pliage facile d'une main
- DE**
- Robustes und ansprechendes Design
  - Einfache Reinigung

Options only available for the products marked with '\*'  
 Optional disponibile solo per i prodotti segnati con '\*'  
 Options seulement disponibles pour les produits désignés par '\*'  
 Optionen nur für die mit \* markierten Modelle

<b>COFFIE *</b>	200 Kg	4 swivel x Ø150 mm 'CMP'	Steel tubing structure with HPL panels Struttura in tubo d'acciaio con pannelli HPL Structure en tubes d'acier avec panneaux en HPL Stahlrohrrahmen mit HPL-Platten	1334x 566x h1491 mm	42 Kg	CAD00047
<b>TRAY STAND W</b>	50 Kg	-	Pine wood with PVC black belts, with backrest Struttura in legno di pino con cinghie nere in PVC Structure en pin avec sangles en PVC noires Kiefernholz mit schwarzem PVC-Branch	600x 500x h800 mm	3,5 Kg	CAD554



## ICE CADDIE

NEW







- EN** • Ideal for ice transport  
• Internal insulation  
• Easy clean up  
• Integrated drain tap
- IT** • Ideale per trasporto ghiaccio  
• Adatto per l'isolamento termico  
• Facile da pulire  
• Tappo per lo scarico incluso
- FR** • Idéal pour le transport de glace  
• Isolation interne  
• Facile à nettoyer  
• Bonde de vidange
- DE** • Ideal für den Eistransport  
• Innen isoliert  
• Einfache Reinigung  
• Mit integriertem Ablaufhahn

## PLATES CADDIE

NEW



- EN** • 6 Adjustable column towers  
• Up to 60 dishes in each column  
• Usable dividers height: 48 cm  
• Protective cover included
- IT** • 6 colonne smontabili, facili da regolare  
• Fino a 60 piatti in ogni colonna  
• Altezza utile della colonna: 48 cm  
• Torri a colonna Pratica cover di chiusura
- FR** • 6 colonnes amovible  
• Jusqu'à 60 assiettes dans chaque colonne  
• Hauteur de colonne utilisable: 48 cm  
• Housse de protection
- DE** • 6 Tellerstapel abnehmbar, Leicht zu Stapel  
• Für ca. 45-60 Teller pro Stapel  
• Nutzbare Stapelhöhe: 48 cm  
• Schutzhülle inklusive

						
<b>ICE CADDIE</b>	125 Ltr.	2 swivel front x Ø125 mm with brake and 2 rear Ø200 mm	Polyethylene Polietilene Polyéthylène Polyethylen	820x 620x h820 mm	27,4 kg	CAD00137
<b>PLATES CADDIE</b>	250 kg	2 swivel x Ø125 mm with brake and 2 fixed Ø250 mm		970x 720x h800 mm	30 Kg	CAD00138



## CADDINOX 2

## CADDINOX 3



- EN**
- 2 or 3 shelves with a perimetric profiled upstand
  - Stainless steel round tube frame, Ø 25 mm
  - Side pushing bars

- IT**
- 2 o 3 ripiani con bordo
  - Struttura in tubo tondo di acciaio inox Ø 25 mm
  - Maniglioni di spinta

- FR**
- 2 ou 3 étagères avec rebord
  - Structure en tube rond en acier inoxydable Ø 25 mm
  - Poigne de pousse

- DE**
- 2 oder 3 Ebenen, jeweils mit Aufkantung
  - Edelstahl Rundrohrrahmen Ø25 mm
  - Schiebebügel
  - 4 Abweisinge

### Options



<b>CADDINOX 2</b>	max. 120 Kg	4 swivel x Ø 125 mm 'TPP'	Stainless steel Acciaio inox Acier inoxydable Edelstahl	890x 590x h950 mm	12,5 Kg	100101IN
<b>CADDINOX 3</b>				1090x 590x h950 mm	19 Kg	100102IN

## SUPER CADDINOX 2



- EN**
- 2 or 3 shelves with a perimetric profiled upstand
  - 4 donut bumpers
  - Stainless steel round tube closed frame, Ø 25 mm

- FR**
- 2 ou 3 étagères avec rebords
  - 4 pare-chocs en caoutchouc
  - Structure en acier inoxydable tube Ø 25mm

## SUPER CADDINOX 3



- IT**
- 2 o 3 ripiani con bordo
  - 4 paracolpi in gomma
  - Struttura in tubo tondo di acciaio inox Ø 25 mm

- DE**
- 2 oder 3 Ebenen, jeweils mit Aufkantung
  - Edelstahl Rundrohrrahmen Ø25 mm
  - Schiebebügel
  - 4 Abweisinge

## Options



<b>SUPER CADDINOX 2</b>	max. 200 Kg	4 swivel x Ø 125 mm 'TPP', 2 of which with brake	Welded stainless steel Acciaio inox saldato Acier inoxydable soudé Geschweißter Edelstahl	1090x 590x h950 mm	17 Kg	100201IN
<b>SUPER CADDINOX 3</b>				1090x 590x h950 mm	22 Kg	100202IN



## VERSO 12

NEW

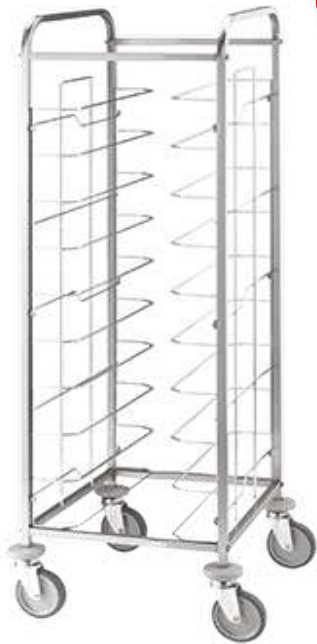

- EN** • 12 tray holder foldable shelves in chrome-plated steel
- Stainless steel square tube construction
  - Suitable for trays of max 53x39 cm

- IT** • 12 ripiani porta vassoi in filo d'acciaio cromato
- Struttura in tubo quadro di acciaio inox
  - Vassoi con dim. max 53x39 cm

- FR** • 12 porte-plateaux en fil acier chromé
- Structure en tube carré en acier inoxydable
  - Plateaux dim. max 53x39 cm

- DE** • 12 klappbare Tablettschübe in verchromtem Stahl
- Edelstahl Vierkantröhrgestell
  - Passend für Tablett max. Maß 53x39 cm

## VERSO 12P

NEW



- EN** • 12 tray holder foldable shelves in chrome-plated steel
- Stainless steel square tube construction with 2-side tobacco oak panels
  - Suitable for trays of max 53x39 cm

- IT** • 12 ripiani porta vassoi in filo d'acciaio cromato
- Struttura in tubo quadro di acciaio inox con pannelli laterali con finitura Rovere Tabacco
  - Vassoi con dim. max 53x39 cm







- FR** • 12 porte-plateaux en fil acier chromé
- Structure en tube carré en acier inoxydable et panneaux latéraux finition Chêne Tabac
  - Plateaux dim. max 53x39 cm

- DE** • 12 klappbare Tablettschübe in verchromtem Stahl
- Edelstahl Vierkantröhrgestell mit 2 Seitenwänden
  - Passend für Tablett max. Maß 53x39 cm

## Options

DR-T



						
<b>VERSO 12</b>	max. 100 Kg	4 swivel x Ø125 mm with donut bumper	Stainless steel frame (with lateral laminated wood Verso 12P)	520x 600x h1830 mm	15,5 Kg	CAD00217
			Struttura in acciaio inox (con pannelli in legno nobilitato Verso 12P)			
<b>VERSO 12P</b>			Structure en tubes d'acier inoxydable (bois MDF finition coloris noir Verso 12P)	520x 600x h1830 mm	25 Kg	CAD00218
			Edelstahlrohr matt (MDF Holz in der Farbe schwarz Verso 12P)			

## VERSO 24

NEW

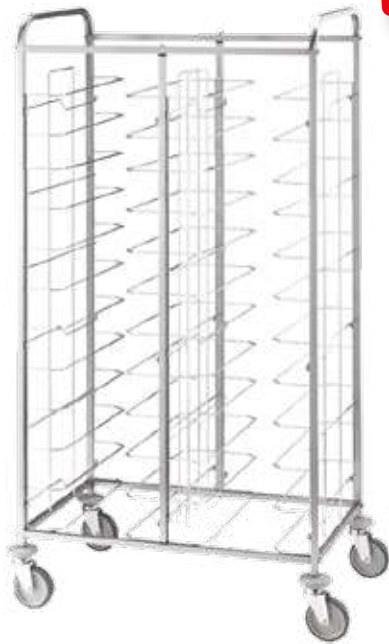

- EN** • 2 compartments of 12 tray holder foldable shelves each in chrome-plated steel
- Stainless steel square tube construction
  - Suitable for trays of max 53x39 cm

- IT** • 2 colonne da 12 ripiani porta vassoi ciascuna in filo d'acciaio cromato
- Struttura in tubo quadro di acciaio inox
  - Vassoi con dim. max 53x39 cm

- FR** • 2 colonnes à 12 niveaux porte plateaux en fil d'acier chromé
- Structure en tube carré en acier inoxydable
  - Plateaux dim. max 53x39 cm

- DE** • 2x 12 klappbare Tablettsschübe in verchromtem Stahl
- Edelstahl Vierkanthohrgestell
  - Passend für Tablettss max. Maß 53x39 cm

## VERSO 24P

NEW



- EN** • 2 compartments of 12 tray holder foldable shelves each in chrome-plated steel
- Stainless steel square tube construction with 2-side tobacco oak stained melamine-faced panels
  - Suitable for trays of max 53x39 cm

- IT** • 2 colonne da 12 ripiani porta vassoi ciascuna in filo d'acciaio cromato
- Struttura in tubo quadro di acciaio inox e pannelli laterali con finitura Rovere Tabacco
  - Vassoi con dim. max 53x39 cm

- FR** • 2 colonnes à 12 niveaux porte plateaux en fil d'acier chromé
- Structure en tube carré en acier inoxydable et panneaux latéraux finition Chêne Tabac
  - Plateaux dim. max 53x39 cm

- DE** • 2x 12 klappbare Tablettsschübe in verchromtem Stahl
- Edelstahl Vierkanthohrgestell mit 2 Seitenwänden
  - Passend für Tablettss max. Maß 53x39 cm

## Options

DR-T



<b>VERSO 24</b>	max. 200 Kg	4 swivel x Ø125 mm with donut bumper	Stainless steel frame (with lateral laminated wood Verso 24P)	950x 600x h1830 mm	25 Kg	CAD00219
			Struttura in acciaio inox (con pannelli in legno nobilitato Verso 24P)			
<b>VERSO 24P</b>			Structure en tubes d'acier inoxydable (bois MDF finition coloris noir Verso 24P)	950x 600x h1830 mm	34,5 Kg	CAD00220
			Edelstahlrohr matt (MDF Holz in der Farbe schwarz Verso 24P)			



ALTO 2

NEW



ALTO 2

- EN • 2 tiers  
 • Tiny elegant chromed details  
 • Side pushing bars

- IT • 2 ripiani  
 • Piccoli dettagli cromati  
 • Maniglie di spinta

- FR • 2 niveaux  
 • Détails en finition chromée  
 • Poigne de pousse

- DE • 2 Etagen  
 • Mit Chrom-Details  
 • Seitliche Schiebegriffe

ALTO 3

NEW



ALTO 3

- EN • 3 tiers  
 • Tiny elegant chromed details  
 • Side pushing bars

- IT • 3 ripiani  
 • Piccoli dettagli cromati  
 • Maniglie di spinta

- FR • 3 niveaux  
 • Détails en finition chromée  
 • Poigne de pousse

- DE • 3 Etagen  
 • Mit Chrom-Details  
 • Seitliche Schiebegriffe

Options



ADDITIONAL MODELS AVAILABLE  
 ALTRI MODELLI DISPONIBILI  
 PLUS DE MODÈLES DISPONIBLES  
 MEHR MODELLE VERFÜGBAR

Panel Finish

SW



RAL

MNO

MGR

MWE

Options only available for the products marked with '\*'  
 Opzionale disponibile solo per i prodotti segnati con '\*'  
 Options seulement disponibles pour les produits désignés par '\*'  
 Optionen nur für die mit \* markierten Modelle

## ALTO FAMBLÈ



ALTO FLAMBÈ + OPTION RJ

NEW

## ALTO 5 PM



ALTO 5PM + OPTION RJ

NEW

- EN** • Stainless steel worktop  
• Equipped with single stove, drawer and an integrated bottle holder

- IT** • Piano in acciaio  
• Dotato di un bruciatore a fuoco singolo, cassetto di servizio e di un portabottiglie integrato nel piano di lavoro

- FR** • Étagère en acier inoxydable  
• Équipé d'un feu, tiroir de service et support bouteilles intégré dans l'étagère supérieur

- DE** • Obere Etage mit Edelstahl ausgelegt  
• Flambierwagen mit einem sicheren Einzel-Spiritusbrenner  
• Mit einer Schublade und einem integriertem Flaschenhalter

- EN** • Integrated display case for food & beverage refrigerated by means of chilling packs  
• Protection frame (included)

- IT** • Dotato di una vetrinetta integrata per il servizio di cibi e bevande, refrigerata con piastre eutettiche  
• Spondine di protezione (incluse)

- FR** • Équipé d'une vitrine réfrigérée avec pack réfrigérant  
• Cadre de protection supérieur (compris)

- DE** • Verfügt über eine integrierte Vitrine für Süßwaren  
• Gekühlt mittels Kühlakkus  
• Obere Etage mit Schutzreling

					
<b>ALTO 2 *</b>	max. 100 Kg	4 swivel x Ø100 mm	Solid wood Legno massello Bois massif Massivholz	1015x 570x h1121 mm	CAD00173
<b>ALTO 3</b>				1015x 570x h1121 mm	CAD00174
<b>ALTO FLAMBÈ</b>				1015x 570x h936 mm	CAD00177
<b>ALTO 5PM</b>				1015x 570x h900 mm	CAD00181



## ALTO WINE

NEW



ALTO WINE + OPTION RJ

## ALTO MIXOLOGY

NEW



ALTO MIXOLOGY + OPTION RJ

- EN** • Equipped by: drawer, glass rack, cork collection pan, bottles display  
 • 4 bottles coolers placed on a chilling pack ensuring up to 5 hours of cooling autonomy

- IT** • Dotato di: cassetto, rastrelliera porta bicchieri, espositore di bottiglie, vaschetta porta tappi  
 • 4 recipienti su piastra eutettica con autonomia fino a 5 ore di servizio

- FR** • Equipé de: tiroir, râtelier à verres, bac de collecte de bouchons, présentoir de bouteilles  
 • Pack réfrigérant assurant jusqu'à 5 heures de refroidissement

- DE** • Schublade, Gläsergestell, Korkauffangschale und Untergestell mit spezieller Anrichte für die Flaschenpräsentation  
 • 4 Flaschenkühler, die auf einem Kühlakku platziert sind und bis zu 5 Stunden Kühltemperatur gewährleisten

- EN** • Stainless steel tiers equipped with 2 GN 1/3 pans, 1 metal box and frontal acrylic glass structure  
 • Double glass/bottle holder structure

- IT** • Piano in acciaio inox con 2 vasche GN 1/3, 1 cassetta e alzatina frontale in plexiglass  
 • Doppia rastrelliera inferiore

- FR** • Étagère supérieur en acier inoxydable équipé de 2 GN 1/3, 1 conteneur métallique et une protection en verre acrylique  
 • Support verres et bouteilles

- DE** • Oberfläche aus Edelstahl und ausgestattet mit zwei GN 1/3 Behälter, 1 Metallbox und einer vertikal aufgestellten Glasscheibe  
 • Mit praktischer Flaschen-Gläser-Halterung

## Options



## Panel Finish

SW



RAL



MNO



MGR



MWE

**ADDITIONAL MODELS AVAILABLE**  
**ALTRI MODELLI DISPONIBILI**  
**PLUS DE MODÈLES DISPONIBLES**  
**MEHR MODELLE VERFÜGBAR**

Options only available for the products marked with '\*'  
 Opzionale disponibile solo per i prodotti segnati con '\*'  
 Options seulement disponibles pour les produits désignés par '\*'  
 Optionen nur für die mit \* markierten Modelle



## ALTO BOLLA

NEW



ALTO BOLLA + OPTION RJ

## ALTO ICE 3

NEW



ALTO ICE 3 + OPTION RJ

- EN** • Equipped by: 2 glass racks, ice bucket and 2 bottle coolers  
• Upper tier is laid with marble materic HPL finish

- IT** • Dotato di: rastrelliere porta bicchieri, secchiello per bottiglie, 2 glacette  
• Ripiano superiore rivestito in HPL finitura marmo

- FR** • Equipé de 2 râteliers en verre et seau à glace  
• Plateau supérieur en HPL finition marbre

- DE** • Verfügt über einen Glasständer aus Acrylglas, Eiskübel und zwei Flaschenkühler  
• Der obere Teil ist mit Marmor ausgelegt

- EN** • 2 to 3 tiers with detachable refrigerated display case with hemispherical dome with double side opening  
• Chilling pack ensuring up to 5 hours of cooling autonomy

- IT** • 2 o 3 ripiani con vetrina espositiva refrigerata asportabile a doppia apertura  
• Refrigerazione tramite piastre eutettiche con autonomia fino a 5 ore di servizio

- FR** • Présentoir réfrigéré détachable avec dôme hémisphérique à double ouverture sur 2 ou 3 étages  
• Pack réfrigérant assurant jusqu'à 5 heures de refroidissement

- DE** • 2 oder 3 Etagen, mit abnehmbarer Kühlvitrine  
• Halbkugelförmige Kuppel, beidseitig zu öffnen  
• Kühlung mittels Kühllakus für bis zu 5 Stunden Betrieb

	 <b>KG</b>				 <b>CODE</b>
<b>ALTO WINE</b>	max. 100 Kg	4 swivel x Ø100 mm	Solid wood Legno massello Bois massif Massivholz	1015x 570x h1019 mm	CAD00178
<b>ALTO BOLLA</b>				1015x 570x h1121 mm	CAD00179
<b>ALTO MIXOLOGY</b>				1015x 570x h1121 mm	CAD00180
<b>ALTO ICE 3 *</b>				1015x 570x h1197 mm	CAD00211



ARTE 2

NEW



ARTE 2

ARTE BM 1

NEW



ARTE BM 1

- EN • 1 tier with solid wood dish holder  
• Double pushing handle

- IT • 1 ripiano con pianetto estraibile  
• Doppia maniglia di spinta

- FR • 1 niveau avec porte-assiettes escamotable  
• 2 poignées de poussée

- DE • Obere Etage mit ausziehbarer Ablage  
• Schiebegriff

- EN • 1 tiers with 16 cm deep tank (Gn pans on request), with drain cock, bain marie heating with digital thermostat  
• Pushing handle

- IT • 1 ripiano rivestito in inox con vasca profonda 16 cm e rubinetto di scarico, riscaldamento a bagno maria con termostato digitale e pianetto extra  
• Maniglia di spinta

- FR • Étagère supérieure en acier inoxydable avec bac profonde 16 cm et robinet de vidange, bain-marie avec thermostat numérique.  
• Poignée de poussée

- DE • Obere Etage mit Becken aus Edelstahl, Tiefe 16 cm, ausgestattet mit Ablasshahn; Bain-Marie Heizung mit digitalem Thermostat  
• Schiebegriff

						
ARTE 2 *	max. 100 Kg	4 swivel x Ø125 mm	Solid wood and stainless steel Legno massello e acciaio inox Bois massif et acier inoxydable Edelstahl und Massivholz	1180x 590x h890 mm	43 Kg	CAD00182
ARTE BM 1 *				1366x 590x h1141 mm		

## ARTE SP

NEW



ARTE SP

- EN** • 2 tiers with retaining bars, glass racks  
• Pushing handle
- IT** • 2 ripiani con spondine di protezione, pianetto estraibile e rastrelliere porta bicchieri  
• Maniglia di spinta
- FR** • 2 niveau avec étagères, cadre de protection et structure porte-verres  
• Poignée de poussée
- DE** • 2 Etagen mit Schutzreling  
• Glashalter aus Acrylglas  
• Seitlich aufklappbare Ablage  
• Schiebegriff

**ADDITIONAL MODELS AVAILABLE**  
ALTRI MODELLI DISPONIBILI  
PLUS DE MODÈLES DISPONIBLES  
MEHR MODELLE VERFÜGBAR

## Options



## Panel Finish

## SWS



RAL



MNO



MGR



MWE

Options only available for the products marked with '\*'  
Optional disponibile solo per i prodotti segnati con '\*'  
Options seulement disponibles pour les produits désignés par '\*'  
Optionen nur für die mit \* markierten Modelle

<b>ARTE SP</b>	max. 100 Kg	4 swivel x Ø125 mm	Solid wood and stainless steel Legno massello e acciaio inox Bois massif et acier inoxydable Edelstahl und Massivholz	1366x 590x h875 mm	60 Kg	CAD00184



NEW

ALU  
MADEIMPROVED AND  
PERFECT FOR  
OUTDOOR USE.

- EN**
- 2 doors with opening at 90° angle
  - Pushing handle
  - 2 height adjustable shelves
  - Ideal for outdoor use

- FR**
- 2 portes ouvrant à 90°
  - Poignée de poussée
  - 2 étagères intérieures amovibles
  - Pour utilisation à l'extérieur

- IT**
- 2 porte con apertura a 90°
  - Maniglia di spinta
  - 2 ripiani interni regolabili in altezza
  - Per uso esterno

- DE**
- 2 Türen mit Öffnungswinkel 90°
  - Schiebegriff
  - 2 verstellbare Einlegeböden
  - Zum externen Gebrauch

## Options



					
<b>CUTTIE</b>	4 swivel x Ø125 mm, 2 of which with brake	Stainless steel Acciaio inox Acier inoxydable Edelstahl	965x 533x h1407 mm	88 Kg	CAD00188

## HOTTIE AIR CR / BR / CP

NEW



HOTTIE AIR CR

NEW



HOTTIE AIR BR





NEW



HOTTIE AIR CP

- EN** • Infrared lamps  
• Available in 3 finishings  
• Height adjustable
- FR** • Lampe infrarouge  
• Disponible en 3 finitions  
• Réglable en hauteur

- IT** • Lampada a infrarossi  
• Disponibile in 3 finiture  
• Altezza regolabile
- DE** • Infrarotlampe  
• Verfügbar in 3 Ausführungen  
• Cabel höhenverstellbar

				
<b>HOTTIE AIR CR</b>	250 W	Stainless steel with chrome (CR) / brass (BR) / copper (CP) finish Acciaio inox cromato (CR) / ottonato (BR) / ramato (CP)	Lamp Ø160 mm, Cable length 500/1000 mm Lampada Ø160 mm, Lunghezza cavo 500/1000 mm	CAD00189
<b>HOTTIE AIR BR</b>		Acier inoxydable chromé (CR) / laitonné (BR) / cuivré (CP)	Lampe Ø160 mm, Longueur du câble 500/1000 mm	CAD00190
<b>HOTTIE AIR CP</b>		Stahl, verchromt (CR) / Stahl, vermessingt (BR) / Stahl verkupfert (CP)	Schirm Ø160 mm, 500/1000 mm Kabellänge	CAD00191



## HOTTIE 1H FIX BR

NEW



## HOTTIE 2H FLEX BR

NEW



EN • Infrared lamp mounted with junction connection

EN • Infrared lamps mounted with flexible tube  
• Acrylic plexiglass sneezeguard

IT • Lampada a infrarossi su snodo

IT • Lampada a infrarossi su tubo flessibile  
• Calottina in plexiglass



FR • Lampe infrarouge

FR • Lampe infrarouge  
• Calotte supérieure fixe

DE • Infrarotlampe

DE • Bewegliche Infrarotlampen  
• Fest montierte Plexiglasscheibe

**ADDITIONAL MODELS AVAILABLE  
ALTRI MODELLI DISPONIBILI  
PLUS DE MODÈLES DISPONIBLES  
MEHR MODELLE VERFÜGBAR**

				
<b>HOTTIE 1H FIX BR</b>	250 W	Stainless steel with chrome (CR) / brass (BR) finish Acciaio inox cromato (CR) / ottonato (BR)	Ø224 (basis) x h734 mm	CAD00192
<b>HOTTIE 2H FLEX BR</b>		Acier inoxydable chromé (CR) / laitonné (BR) Stahl, verchromt (CR) / Stahl, vermessingt (BR)		

## HOTTIE-P 1H FLEX CR

NEW



- EN** • Infrared lamp mounted with flexible tube  
• Heated warming plate with thermostat  
• Acrylic plexiglass sneezeguard

- IT** • Lampada a infrarossi su tubo flessibile  
• Piano riscaldato a secco con termostato  
• Calottina in plexiglass

- FR** • Lampe infrarouge  
• Chauffage à sec avec thermostat mécanique  
• Calotte supérieure fixe

- DE** • Bewegliche Infrarotlampe mit Wärmepatte  
• Warmhalteplatte mit Thermostat  
• Fest montierte Plexiglasscheibe

## HOTTIE-P 2H FIX CR

NEW







- EN** • Infrared lamps mounted with junction connection  
• Heated warming plate with thermostat  
• Acrylic plexiglass sneezeguard

- IT** • Lampada a infrarossi su snodo  
• Piano riscaldato a secco con termostato  
• Calottina in plexiglass

- FR** • Lampes infrarouge  
• Chauffage à sec avec thermostat mécanique  
• Calotte supérieure fixe

- DE** • Infrarotlampen mit Wärmeplatte  
• Warmhalteplatte mit Thermostat  
• Fest montierte Plexiglasscheibe

**ADDITIONAL MODELS AVAILABLE**  
**ALTRI MODELLI DISPONIBILI**  
**PLUS DE MODÈLES DISPONIBLES**  
**MEHR MODELLE VERFÜGBAR**

				
<b>HOTTIE-P 1H FLEX CR</b>	250 W	Stainless steel with chrome (CR) / brass (BR) finish Acciaio inox cromato (CR) / ottonato (BR)	540x 447x h913 mm	CAD00194
<b>HOTTIE-P 2H FIX CR</b>		Acier inoxydable chromé (CR) / laitonné (BR) Stahl, verchromt (CR) / Stahl, vermessingt (BR)	660x 552x h750 mm	CAD00196



## HOTTIE BOARD G

NEW



- EN** • Heated warming plate with mechanical thermostat
- Indicator light
  - Black tempered glass shelf

- IT** • Piano riscaldato a secco con termostato meccanico
- Spia luminosa di funzionamento
  - Piano in vetro temperato nero

- FR** • Plaque de cuisson avec thermostat mécanique
- Voyant lumineux de fonctionnement
  - Plaque chauffante en verre trempé noir

- DE** • Warmhalteplatte mit Thermostat
- Leuchtanzeige

## HOTTIE BOARD 60X40

NEW







- EN** • Heated warming plate with mechanical thermostat
- Indicator light

- IT** • Piano riscaldato a secco con termostato meccanico
- Spia luminosa di funzionamento

- FR** • Chauffage à sec avec thermostat mécanique
- Voyant lumineux de fonctionnement

- DE** • Warmhalteplatte mit Thermostat
- Leuchtanzeige

**ADDITIONAL MODELS AVAILABLE**  
**ALTRI MODELLI DISPONIBILI**  
**PLUS DE MODÈLES DISPONIBLES**  
**MEHR MODELLE VERFÜGBAR**

					
<b>HOTTIE BOARD G</b>	750 W	Stainless steel Acciaio inox Acier inoxydable Edelstahl	330x 560 mm	6 Kg	CAD00197
<b>HOTTIE BOARD 60X40</b>			430x 600 mm	9 Kg	CAD00198



## HOTTIE-P 2 L

NEW



- EN • Infrared lamps with acrylic plexiglass sneeze guard  
 • Heated warming plate with mechanical thermostat  
 • Indicator light

- IT • Lampade a infrarossi con calottina in plexiglass  
 • Piano riscaldato a secco con termostato meccanico  
 • Spia luminosa di funzionamento

- FR • Lampes infrarouge avec calotte supérieure fixe  
 Chauffage à sec avec thermostat mécanique  
 • Voyant lumineux de fonctionnement

- DE • Infrarotlampen mit fest montiertem Plexiglasdach  
 • Warmhalteplatte mit mechanischem Thermostat  
 • Leuchtanzeige

## HOTTIE-P 3 L

NEW







- EN • Infrared lamps with acrylic plexiglass sneeze guard  
 • Heated warming plate with mechanical thermostat  
 • Indicator light

- IT • Lampade a infrarossi con calottina in plexiglass  
 • Piano riscaldato a secco con termostato meccanico  
 • Spia luminosa di funzionamento

- FR • Lampes infrarouge avec calotte supérieure fixe  
 Chauffage à sec avec thermostat mécanique  
 • Voyant lumineux de fonctionnement

- DE • Infrarotlampen mit fest montiertem Plexiglasdach  
 • Warmhalteplatte mit mechanischem Thermostat  
 • Leuchtanzeige

**ADDITIONAL MODELS AVAILABLE**  
**ALTRI MODELLI DISPONIBILI**  
**PLUS DE MODÈLES DISPONIBLES**  
**MEHR MODELLE VERFÜGBAR**

					
<b>HOTTIE-P 2L</b>	500+750 W	Stainless steel Acciaio inox Acier inoxydable	706x 553x h831 mm	18 Kg	CAD00199
<b>HOTTIE-P 3L</b>	1500+750 W	Edelstahl	1036x 553x h831 mm	25 Kg	CAD00200



**CMM**

Housing made of pressed steel, bright zinc plated  
Wheel center made of polypropylene  
Double ball bearing  
Thermoplastic rubber tread  
Can be used for many floor types  
Very durable  
Very good maneuverability  
Tread leaves no marks on the floor

Supporto in lamiera d'acciaio zincato  
Nucleo in polipropilene  
Doppio giro di cuscinetti a sfera  
Rivestimento in gomma termoplastica  
Possono essere utilizzate su diversi tipi di superficie  
Molto resistenti  
Ottima manovrabilità  
Antitraccia

Chappe en acier galvanisé brillant  
Corps de galet en polypropylène  
Double roulement à billes  
Bandage caoutchouc  
Utilisation possible sur de nombreux type de sols  
Très durable  
Très bonne maniabilité  
Non marquantes

Gehäuse aus verzinktem Stahl  
Radkörper aus Polypropylen  
Doppeltes Kugellager  
Lauffläche aus einer thermoplastischen Gummimischung  
Für viele Bodentypen geeignet  
Sehr stabil  
Leicht gängig  
Hinterlässt keine Finituraspuren auf Böden

**CMP**

Housing made of Polyamid in RAL 7001  
Double ball bearing  
Thermoplastic rubber tread  
Ideal for hard and even floors  
Very quiet  
Non-corrosive  
Tread leaves no marks on the floor

Supporto poliammide RAL 7001  
Doppio giro di cuscinetti a sfera  
Rivestimento in gomma termoplastica  
Ideali per superfici dure e regolari  
Molto silenziose  
Anticorrosione  
Antitraccia

Chappe en polyamide gris RAL 7001  
Double roulement à billes  
Bandage caoutchouc  
Idéales pour sols durs et réguliers  
Très silencieuses  
Absence de risque de corrosion  
Non marquantes

Kunststoffgabel aus Polyamid in RAL 7001  
Doppeltes Kugellager  
Lauffläche aus einer thermoplastischen Gummimischung  
Für ebene und eher harte, feinfugige Bodentypen geeignet  
Sehr leise  
Keine Korrosion  
Hinterlässt keine Spuren auf Böden

**PNP**

Wheel center made of polypropylene  
Foamed polyurethane tread  
Precision ball bearing  
Only for Orsa  
Can be used for many floor types, also for outdoor  
Almost wear-free  
Low rolling-resistance

Nucleo in polipropilene  
Rivestimento in schiuma poliuretana  
Cuscinetti a sfera di precisione  
Possono essere utilizzate su diversi tipi di superficie, anche all'esterno  
Praticamente indistruttibili  
Ottima scorrevolezza

Corps de galet en polypropylène  
Roulement à billes de précision  
Bandage en polyuréthane moussé  
Seulement pour Orsa  
Utilisation possible sur de nombreux types de sols, également en extérieur  
Quasi-inusables  
Faible résistance au roulement

Radkörper aus Polypropylen  
Lauffläche aus geschäumtem Polyurethan  
Präzisionskugellager  
Für viele Bodentypen geeignet, auch Outdoor  
Nahezu verschleißfrei  
Geringer Rollwiderstand

**RG**

Housing made of pressed steel, bright zinc plated  
Double ball bearing  
Elastic rubber tread  
Ideal for hard and uneven floors  
Vibration absorbent  
Very quiet

Supporto in lamiera d'acciaio con zincatura brillante  
Doppio giro di cuscinetti a sfera  
Rivestimento in gomma elastica  
Ideali per superfici dure e irregolari  
Antivibrazione  
Molto silenziose

Chappe en acier galvanisé brillant  
Double roulement à billes  
Bandage caoutchouc élastique  
Idéales pour sols durs et irréguliers  
Absorbe les vibrations  
Très silencieuses

Gehäuse aus verzinktem Stahl  
Doppeltes Kugellager  
Lauffläche aus elastischem Gummi  
Ideal für harte und unebene Böden  
Schwingungsabsorbierend  
Sehr leise

**RJ**

Double ball bearing  
Elastic rubber tread  
Ideal for hard and uneven floors  
Vibration absorbent  
Very quiet

Doppio giro di cuscinetti a sfera  
Rivestimento in gomma elastica  
Ideali per superfici dure e irregolari  
Antivibrazione  
Molto silenziose

Double roulement à billes  
Bandage caoutchouc élastique  
Idéales pour sols durs et irréguliers  
Absorbe les vibrations  
Très silencieuses

Doppeltes Kugellager  
Lauffläche aus elastischem Gummi  
Ideal für harte und unebene Böden  
Schwingungsabsorbierend  
Sehr leise



## RNY

Housing made of pressed steel, bright zinc plated  
Double ball bearing swivel head  
Plain bearing  
Nylon tread  
Ideal for soft floors such as deep carpet  
Very durable and wear-free  
Very good maneuverability

Supporto in lamiera d'acciaio con zincatura brillante  
Doppio giro di cuscinetti a sfera sul supporto girevole  
Foro passante  
Rivestimento in nylon  
Ideali per superfici morbide come la moquette  
Molto solide e resistenti  
Ottima manovrabilità

Chappe en acier galvanisé brillant  
Pivot à double roulement à billes  
Roulement à billes  
Bandage dur nylon  
Idéales pour sols souples type moquette profonde  
Très durables et solides  
Très bonne maniabilité

Gehäuse aus glanzverzinktem Stahlblech  
Schwenklager mit zweifachem Kugelkranz  
Gleitlager  
Lauffläche aus Polyamid/Nylon  
Ideal für weiche Böden wie tiefflorige Teppiche  
Sehr langlebig und wartungsfrei  
Gute Manövrierbarkeit



## RSS

Wheels center made of polypropylen  
Full rubber tread  
Roller bearing  
Gentle to floor thanks to the soft material  
Excellent maneuverability and rotation capacity

Nucleo in polipropilene  
Cuscinetti a rulli  
Rivestimento in gomma  
Materiale morbido che preserva le superfici  
Ottima manovrabilità e capacità di rotazione

Corps de galet en polypropylène  
Bandage caoutchouc plein  
Roulement à rouleau  
Matériau très souple, préservant le revêtement de sol  
Très bonne maniabilité et capacité à la rotation

Radkörper aus Polypropylen  
Lauffläche aus Vollgummi  
Rollenlager  
Sehr bodenschonend, da sehr weiches Material  
Leichte Manövrierbarkeit / Drehbarkeit



## TPP

Housing made of high grade synthetic material  
Double ball bearing swivel head  
Precision ball bearing  
Thermoplastic rubber tread  
Very quiet  
Tread leaves no marks on the floor  
Non-corrosive  
Vibration absorbent

Supporto in materiale plastico di alta qualità  
Doppio giro di cuscinetti a sfera sul supporto girevole  
Cuscinetti a sfera di precisione  
Rivestimento in gomma termoplastica  
Molto silenziose  
Resistente alla corrosione  
Antitraccia  
Antivibrazione

Chappe en matériau plastique haute qualité  
Pivot à double roulement à billes  
Roulement à billes de précision  
Bandage caoutchouc  
Très silencieuses  
Non marquantes  
Absence de risque de corrosion  
Absorbe les vibrations

Gehäuse aus hochwertigem Kunststoff  
Schwenklager mit zweifachem Kugelkranz  
Präzisionskugellager  
Lauffläche aus einer thermoplastischen Gummimischung  
Sehr leise  
Hinterlässt keine Spuren auf Böden  
Keine Korrosion  
Schwungsabsorbierend



## TPS

Housing made of pressed steel, bright zinc plated  
Roller bearing  
Thermoplastic rubber tread  
Can be used for many floor types  
Very quiet  
Tread leaves no marks on the floor  
Non-corrosive  
Vibration absorbent

Supporto in lamiera d'acciaio con zincatura brillante  
Cuscinetti a rulli  
Rivestimento in gomma termoplastica  
Possono essere utilizzate su diversi tipi di superficie  
Molto silenziose  
Resistente alla corrosione  
Antitraccia  
Antivibrazione

Chappe en acier galvanisé brillant  
Roulement à rouleau  
Bandage caoutchouc  
Utilisation possible sur de nombreux types de sols  
Très silencieuses  
Absence de risque de corrosion  
Non marquantes  
Absorbe les vibrations

Gehäuse aus glanzverzinktem Stahlblech  
Kugellager  
Lauffläche aus einer thermoplastischen Gummimischung  
Für viele Bodentypen geeignet  
Sehr leise  
Hinterlässt keine Finituraspuren auf Böden  
Keine Korrosion  
Schwungsabsorbierend



## TT

Wheel center made of pressed steel  
Only for Orsa  
Pneumatic wheels, tread leaves no marks on the floor  
Roller bearing  
High load capacity, antislip  
Easy crossing of threshold

Nucleo in lamiera d'acciaio  
Solo per Orsa  
Ruota pneumatica, antitraccia  
Cuscinetti a rulli  
Grande portata, antiscivolo  
Adatte a superare piccoli ostacoli

Corps de galet en acier  
Seulement pur Orsa  
Bandage pneumatique, non marquantes  
Roulement à billes  
Haute charge utilis, antidérapantes  
Facilite le passage de petits obstacles

Radkörper aus Stahlblech  
Nur für Orsa  
Luftbereifung mit Blockprofil  
Kugellager  
Hohe Zuladung möglich, Rutschfest  
Einfaches Überwinden von Schwellen



**Broom clip**  
One broom clip, possibility to add more  
**Clip per scopa**  
Clip per scopa, possibilità di aggiungerne altre

**Clip à balai**  
Un seul clip à balai, possibilité d'en ajouter d'autres  
**Besensclip**  
Ein Besensclip, erweiterbar



**Linen bag holder, powder coated**  
Upper liftable holder  
Lower liftable base with metal bars and abrasion-proof, non-marking donut bumpers Ø 100 mm  
Robust, water-repellent PES laundry bag (127 Ltr.) in burgundy red  
**Kit sacco biancheria BDX**  
Supporto superiore ribaltabile  
Supporto inferiore ribaltabile con barre in metallo e ruote paracolpo antitraccia Ø 100 mm  
Sacco biancheria bordeaux PES idrorepellente (127 Ltr.)

**Support sac à linge**  
Support relevable supérieur  
Support inférieur relevable avec barres anti-affaissement et 2 pare-chocs annulaires d'angle non marquant Ø 100 mm  
Sac à linge hydrophobe très solide coloris bordeaux 127 Ltr.

**Wäschesackhalterung, pulverbeschichtet**  
Obere, hoch klappbare Halterung  
Untere, hoch klappbare Ablage mit Metallstreben und nicht abfärbende Abweisrollen Ø 100 mm  
Robuster, wasserabweisender PES-Wäschesack 127 Ltr. in bordeaux



**Complete set baby bed**  
Set composed by: pillowcase 38x57 cm, fitted sheet for cot 100x155 cm, sheet 120x170 cm  
**Set completo letto bimbo**  
Set composto da: lenzuolo da sopra misura 120x170 cm, lenzuolo da sotto con angoli misura totale 100x155 cm, federe sacchetto misura 38x57 cm

**Set complet pour lit bébé**  
Ensemble composé d'une taie d'oreiller 38x57 cm, drap housse pour lit bébé 100x155 cm, drap 120x170 cm  
**Komplettes Baby Bett Set**  
Set bestehend aus Kissenbezug 38x57 cm, Spannbetttuch für Kinderbett 100x155 cm, Blatt 120x170 cm

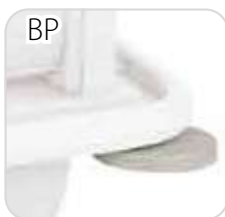

**4 additional donut bumpers on each of the trolley's corner**  
Soft, non-marking material  
Light-grey, RAL 9006  
**Kit paracolpi su ogni angolo del carrello**  
Materiale flessibile e antitraccia  
Colore grigio chiaro, RAL 9006

**4 pare-chocs annulaires d'angle sur chariot**  
Matériau souple et non-marquant  
Gris clair, RAL 9006  
**4 zusätzliche Abweiringe am Stoßschutz, Ø 90mm**  
Weiches, nicht abfärbendes Material  
Hellgrau, RAL 9006

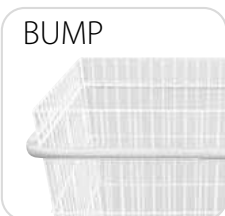

**Full wrap-around bumper**  
**Paracolpo perimetrale in gomma**

**Pare-chocs périmétrique en caoutchouc**  
**Oben umlaufender rundum Gummistoßschutz**



**Small items box, metal (without lid)**  
Adjustable separators made of HPL (size S=1pc. / size M=2pcs. / size L=3pcs.), height 10 cm  
Pre-punched for mechanical fixing into trolley top  
**Cassetta porta oggetti superiore in metallo senza coperchio**  
Separatori regolabili in HPL (1 nel modello S, 2 nel modello M, 3 nel modello L), 10 cm di altezza  
Preforata per il fissaggio sul carrello

**Casier à produits d'accueil métallique (sans couvercle)**  
Séparateurs ajustables en HPL (taille S: 1pc / taille M: 2 pcs / taille L: 3pcs), hauteur 10 cm  
Fond pré-percé pour fixation mécanique sur la galerie supérieur d'un chariot  
**Kleinartikelkasten aus Metall ohne Deckel**  
Variable Trennsteg aus HPL (Maße S=1 Stk. / Maße M = 2 Stk. / Maße L = 3 Stk.) Seitenhöhe 10 cm  
Vorgelocht für Verschraubung mit der obersten Ebene



**Small items metal box with lid**  
Adjustable separators made of HPL (size S=1pc. / size M=2pcs. / size L=3pcs.)  
Height 10cm  
Pre-punched for mechanical fixing into trolley top  
Handle with chrome finish, soft closing  
**Cassetta porta oggetti superiore in metallo con coperchio**  
Separatori regolabili in HPL (1 nel modello S, 2 nel modello M, 3 nel modello L)  
10 cm di altezza  
Preforata per il fissaggio sul carrello  
Maniglia cromata, cerniere idrauliche

**Casier à produits d'accueil métallique (avec couvercle)**  
Séparateurs ajustables en HPL (taille S: 1pc / taille M: 2 pcs / taille L: 3pcs)  
Hauteur 10 cm  
Fond pré-percé pour fixation mécanique sur la galerie supérieur d'un chariot  
Poignée chromée, fermeture amortie  
**Kleinartikelkasten aus Metall mit abschließbarem Deckel**  
Variable Trennsteg aus HPL (Maße S=1 Stk. / Maße M = 2 Stk. / Maße L = 3 Stk.)  
Seitenhöhe 10 cm  
Vorgelocht für Verschraubung mit der obersten Ebene  
Verchromter Handgriff

# OPTIONS | OPTIONEN

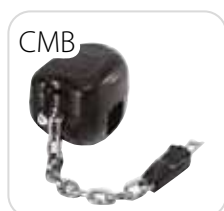

**Coin lock**  
Unlock system for luggage trolley Colysee and Equinox 27 Incl: chain with key.

**Coin lock**  
Sistema di sblocco per carrello portabagagli Colysee ed Equinox 27. Incl: catena con chiave.



**Protective cover, individually made**  
PVC coated fabric with robust structure  
Various colours available  
Optional logo printing  
Curtain with 2 side opening

**Copertura protettiva**  
PVC, molto robusto  
Diversi colori disponibili  
Possibilità di aggiungere il logo  
Apertura su due lati



**Big drawer**  
Drawer with inner Separators and shelf

**Cassetto capiente**  
Cassetto con separatori interni e ripiano estraibile



**Metal drawer**  
Adjustable separators made of HPL  
(size S=1 pc. / size M=2pcs. / size L=3pcs.)  
Sturdy metal rails  
Soft closing  
Integrated, mechanical pullout stop

**Cassetto interno in metallo**  
Separatori interni in HPL  
(1 nel modello S, 2 nel modello M, 3 nel modello L)  
Guide metalliche  
Meccanismo di sicurezza contro le aperture accidentali



**Small item box with 6 separators**  
Adjustable separators made of HPL

**Cassetta con 6 separatori in HPL**  
Separatori regolabili in HPL



**Metal document holder/drawer**  
Sturdy metal rails  
Manual locking  
Integrated, mechanical pull out stop

**Portadocumenti in metallo**  
Robuste guide metalliche  
Blocco manuale  
Arresto di estrazione meccanico integrato



**Doors lockable in laminated wood**  
Size S=1 door, size M=2 doors, size L=2 doors  
Dormant lock, 2 keys  
Upper magnetic latches

**Chiusura con porte in legno laminato**  
1 porta per il modello S, 2 porte per i modelli M e L  
Maniglia inclusa nel meccanismo di chiusura, 2 chiavi  
Fermi magnetici



**Selective waste sorting kit**  
3 plastic containers  
Lower liftable base with metal bars and 4 donut bumpers

**Kit raccolta differenziata**  
3 contenitori di plastica  
Supporto inferiore ribaltabile con ruotine paracolpo

**Consigneur**  
Consigneur pour pièce de 1 EURO compatible avec chariot Colysee et Equinox 27. Inc: chaîne avec clé

**Münzschloss**  
Entriegelungssystem für Gepäckwagen Colysee und Equinox 27. Inklusive: Kette mit Schlüssel.

**Housse de protection**  
Matériau PVC lisse renforcé, très robuste  
Plusieurs coloris disponibles  
Option impression logo  
Rideau avec 2 ouvertures

**Hochwertige Schutzhülle, individuell angefertigt**  
PVC beschichtetes Gewebe, sehr stabile Struktur  
Verschiedene Farben zur Auswahl  
Logo-Druck möglich  
Öffnung an zwei Seiten

**Grand tiroir**  
Tiroir avec séparateurs et étagère

**Große Schublade**  
Schublade mit Inneneinteilung und Regalboden

**Tiroir métallique**  
Séparateurs ajustables en HPL  
(taille S: 1 pc / taille M: 2 pcs / taille L: 3pcs)  
Glissières métalliques  
Loquet fermeture tiroir amorti  
Mécanisme de blocage anti-ouverture accidentelle

**Metallschublade**  
Variable Inneneinteilung aus HPL  
(Maße S=1 Stk. / Maße M = 2 Stk. / Maße L = 3 Stk.)  
Stabile Metall-Führungsschienen  
Manuelle Verriegelung  
Mechanischer Auszugstopp

**Casier à produits avec 6 séparateurs**  
Séparateurs ajustables en HPL

**Kleinartikellkasten mit 6 Inneneinteilungen aus HPL**  
Variable Trennstege aus HPL

**Porte-documents en métal**  
Rails métalliques robustes  
Verrouillage manuel  
Butée d'extraction mécanique intégrée

**Dokumenten Schublade aus Metall**  
Stabile Metall-Führungsschiene  
Manuelle Verriegelung  
Mechanischer Auszugstopp

**Portes verrouillables en bois mélaminé**  
Taille S : 1 porte, taille M et L : 2 portes  
Poignée et verrou encastrés et incrustés, 2 clés  
Loquet magnétique supérieur

**Türen, abschließbar melaminharzbeschichtetes Holz**  
S=1 Türe, M=2 Türen, L=2 Türen  
Flach versenktes Schloss, 2 Schlüssel  
Obere Magnetarretierungen

**Kit tri sélectif**  
3 conteneurs en plastique  
Support inférieur relevable avec barres métalliques anti-affaissement et pare-chocs annulaires d'angle

**Selektives Abfallsortierkit**  
3 Kunststoffbehälter  
Untere, hoch klappbare Ablage mit Metallstreben und nicht abfärbende Abweisrollen Ø 100 mm

DR-T

**Drawer for Verso**

Removable stainless steel container  
**Bacinella estraibile per carrelli Verso**  
 Bacinella estraibile in acciaio inox

e-DRIVE

**e-DRIVE**

Fifth motorized wheel (forward and backward)  
 electrically operated by knob  
 180w 24v electric motor with electromagnetic  
 unlockable brake  
 2 wheels polyurethane bandage diameter 160 mm  
 2 batteries + charger + battery charge level indicator  
 Control button box in painted plastic  
 Made in France and Certificate of Integrability CE

**e-DRIVE**

Quinta ruota motorizzata azionata elettricamente tramite  
 manopola  
 Motore elettrico 180w 24v con freno elettromagnetico  
 sbloccabile  
 2 ruote diametro 160 mm  
 2 batterie + caricabatterie + indicatore livello carica batteria  
 Pulsantiera di comando in plastica verniciata  
 Prodotto in Francia e certificato di integrabilità CE

E / R

**Shutter lockable**

Upper snap closure, 2 keys  
**Chiusura scorrevole**  
 Fermi magnetici, 2 chiavi

ET

**Removable shelf for roll container, electrolytically galvanized**

Dimensions LxW in mm: 696x724, unit weight: 3,6 kg  
 Mesh dimensions in mm: 60x130  
**Ripiano amovibile per roll container in filo d'acciaio zincato**  
 Dimensioni LxP 696x724 mm, peso 3,6 kg  
 Dimensione della maglia 60x130 mm

EXB

**Extra base**

Lower extensible-liftable base with metal bars and  
 abrasion-proof, non-marking donut bumpers Ø 100 mm  
 Maximum weight supported 10 kg

**Extra base**

Base allungabile e sollevabile inferiore con barre  
 metalliche e antiabrasione, paraurti a ciambella  
 antitraccia Ø 100 mm  
 Peso massimo supportato 10 kg

GR

**Mesh shelf**

Height adjustable mesh shelf  
**Ripiano in rete**  
 Ripiano in rete regolabile in altezza

KC

**Lock with combination**

**Chiusura con serratura con combinazione**

LID

**Lockable metal lid for top shelf, powder coated**

Handle with chrome finish  
 Adjustable separators made of HPL (S=1 pc.  
 lengthwise, 1 depthwise / M=1 pc. lengthwise,  
 2 depthwise / L=1 pc. lengthwise, 3 depthwise)  
**Coperchio in metallo verniciato con serratura**  
 Maniglia cromata  
 Separatori regolabili in HPL (S= 1 sep. in larghezza e 1  
 in profondità, M= 1 sep. in larghezza e 2 in profondità,  
 L= 1 sep. in larghezza e 3 in profondità)

**Tiroir pour Verso**

Réceptacle amovible en acier inoxydable  
**Abnehmbarer Edelstahlbehälter für VERSO**

**e-DRIVE**

Cinquième roue motorisée (avant et arrière) actionnée  
 électriquement par bouton  
 Moteur électrique 180w 24v, frein électromagnétique  
 déverrouillable  
 2 roues bandage polyuréthane diamètre 160 mm  
 2 batteries + chargeur + voyant de niveau de charge des batteries  
 Boite à boutons de commande en plastique peint  
 Fabriqué en France et Certificat d'intégrabilité CE

**e-DRIVE**

Fünftes motorisiertes Rad (vorwärts und rückwärts)  
 elektrisch betätigt durch Knopf  
 Elektromotor 180w 24v mit elektromagnetischem  
 entriegelbarer Bremse  
 2 Räder Polyurethan-Bandage Durchmesser 160 mm  
 2 Batterien + Ladegerät + Ladezustandsanzeige  
 Bedientastenbox aus lackiertem Kunststoff  
 Made in France und Zertifikat der Integrierbarkeit CE

**Volet roulant verrouillable**

Fermeture à bouton-pression, 2 clés  
**Kunststoff Rollo, abschließbar**  
 Obere Magnetarretierungen, 2 Schlüssel

**Etagère amovible pour container roll en fil d'acier soudé et électro-galvanisé**

Dimensions LxI. en mm: 696x724, poids : 3,6 kg  
 Dimensions des mailles en mm: 60x130

**Elektrolytisch verzinktes Einlegegitter**

Maße LxB mm: 696x724, Gewicht: 3,6 kg  
 Maschenweite 60x130

**Base extensible**

Support inférieur extensible-relevable avec barres  
 anti-affaissement et 2 pare-chocs annulaires d'angle non  
 marquants Ø 100 mm.  
 Poids maximum supporté 10 kg

**Zusätzliche Basis**

Untere ausziehbare und anhebbare Basis in Metal und  
 abriebfesten, nicht abfärbende Abweisinge Ø 100 mm  
 Maximales unterstütztes Gewicht 10 kg

**Etagère en fil**

Étagère en maille réglable en hauteur

**Gitterrost**

Höhenverstellbare Gitterablage

**Verrou à combinaison**

**Abschließbares Zahlenschloss**

**Capot métallique verrouillable intégré**

Poignée chromée  
 Séparateurs ajustables en HPL (1 pc. en longueur et en  
 largeur: taille S: 1 pc / taille M: 2 pcs. / taille L: 3 pcs.)

**Abschließbarer Metalldeckel für oberste Etagé, pulverbeschichtet**

Verchromter Handgriff  
 Variable Inneneinteilung aus HPL (1 vertikaler, 1 senkrechter  
 Trennsteg für S / 1 vertikaler, 2 senkrechte Trennsteg für M /  
 1 vertikaler, 3 senkrechte Trennsteg für L)

# OPTIONS | OPTIONEN



**Carpet with logo**  
Weaved in logo (in all colors, sizes and variations)  
Individual production

**Moquette personalizzabile**  
Possibilità di inserire il logo in qualsiasi colore, taglia e variante  
Produzione su misura

**Moquette avec logo**  
Logo avec taille et couleur au choix  
Production à la pièce

**Teppich mit individuellem Logo**  
Eingewebtes Logo (in allen Farben, Maßen und Varianten)  
Individuelle Fertigung



**Belt with logo for Retrax**  
Weaved in logo (in all colors and variations)

**Nastro personalizzabile per Retrax**  
Possibilità di inserire il logo in qualsiasi colore e variante

**Sangle avec logo pour Retrax**  
Logo avec taille et couleur au choix

**Band mit individuellem Logo für Retrax**  
Eingewebtes Logo (in allen Farben und Varianten)



**Plaque with personalized logo**  
Possibility to customize the graphics

**Placca con logo personalizzato**  
Possibilità di personalizzare la grafica

**Plaque avec logo personnalisé**  
Possibilité de personnaliser les graphiques

**Werbeplatte mit personalisiertem Logo**  
Möglichkeit zum Anpassen der Grafiken



**Sheathing made of synthetic leather**  
Available colors: red, blue and black  
Velcro fastener, height: 250 mm

**Manopole in pelle sintetica**  
Disponibili in rosso, blu e nero  
Chiusura con velcro spessore 250 mm

**Manchons de préhension en cuir synthétique**  
Disponibles en rouge, bleu et noir  
Accroche velcro, hauteur: 250 mm

**Griff-Ummantelung aus Kunstleder**  
Erhältlich Farben: Rot, Blau und Schwarz  
Klettverschluss, Höhe: 250 mm



**Additional foldable foam mattress**  
Dimensions: 120x 60x 6 cm  
Weight: 1 kg

**Materassino extra pieghevole in schiuma**  
Dimensioni: 120x 60x 6 cm  
Peso: 1 kg

**Matelas en mousse pliable supplémentaire**  
Dimensions: 120x 60x 6 cm  
Poids: 1 kg

**Zusätzliche faltbare Schaumstoff Matratze**  
Abmessungen: 120x 60x 6 cm  
Gewicht: 1 kg



**Neutral plate for Volo trolley**  
Dimensions: 400x h200 mm  
Optional logo printing

**Placca per carrello porta bagagli Volo**  
Dimensioni: 400x h200 mm  
Possibilità di aggiungere il logo

**Plaque neutre pour VOLO**  
Dimensions: 400x h200 mm  
Option impression logo

**Werbeplatte für Volo Trolley**  
Abmessungen: 400x h200 mm  
Logo-Druck möglich



**Bucket holder, powder coated**  
Lower, full steel base, dimension 354x566 mm LxW  
2 buckets, 12 Ltr. each (red and blue)  
2 bumpers Ø100 mm

**Kit porta secchi**  
Supporto inferiore in acciaio, ribaltabile  
2 secchi da 12 Ltr. (uno rosso e uno blu)  
2 routine paracolpo Ø100 mm

**Porte-seaux finition peinte**  
Support seaux relevable en acier dimensions 354x566 mm LxW  
2 seaux de 12 Ltr. (rouge et bleu)  
2 pare-chocs annulaires d'angle Ø100 mm

**Eimerhalterung, pulverbeschichtet**  
Untere Ablage aus Metall  
2 Eimer à 12 Ltr. (Rot und Blau)  
2 Abweisrollen Ø100 mm



**Waste bag holder, powder coated**  
Upper liftable holder  
Stable, black plastic lid with Caddie logo  
Lower liftable base with metal bars and abrasion-proof, non-marking donut bumpers Ø 100 mm

**Kit sacco spazzatura**  
Supporto superiore ribaltabile  
Coperchio nero in plastica con logo Caddie  
Supporto inferiore ribaltabile con barre in metallo e ruote paracolpo antiradice Ø100 mm

**Support sac à déchets**  
Support supérieur relevable  
Couvercle noir en plastique avec logo Caddie  
Support inférieur relevable avec barres anti-affaissement  
2 pare-chocs annulaires d'angle non marquants Ø100 mm

**Müllsackhalterung, pulverbeschichtet**  
Obere, hoch klappbare Halterung  
Stabiler, schwarzer Kunststoff-Deckel mit Caddie Logo  
Untere, hoch klappbare Ablage mit Metallstreben und nicht abfärbende Abweisrollen Ø 100 mm

PVC / BDx

**Waste bag holder with mask bag, powder coated**

Upper liftable holder  
Stable, black plastic lid with Caddie logo  
Water-repellent PES laundry bag (127 Ltr.) in burgundy red  
Lower liftable base with metal bars and abrasion-proof, non-marking donut bumpers Ø 100 mm

**Kit sacco spazzatura con sacco maschera BDx**

Supporto superiore ribaltabile  
Coperchio nero in plastica con logo Caddie  
Sacco maschera bordeaux PES idrorepellente (127 Ltr.)  
Supporto inferiore ribaltabile con barre in metallo e ruote paracolpo antitraccia Ø100 mm

**Support sac à déchets avec sac de cache**

Support supérieur relevable  
Couvercle noir en plastique avec logo Caddie  
Sac à linge hydrophobe très solide coloris bordeaux 127 Ltr.  
Support inférieur relevable avec barres anti-affaissement  
2 pare-chocs annulaires d'angle non marquants Ø100 mm

**Müllsackhalterung, pulverbeschichtet, mit BDx-Sichtschuttsack**

Obere, hoch klappbare Halterung  
Stabiler, schwarzer Kunststoff-Deckel mit Caddie Logo  
Bordeaux-farbener, robuster BDx-Sichtschuttsack (127 Ltr.)  
Untere, hoch klappbare Ablage mit Metallstreben und nicht abfärbende Abweisrollen Ø 100 mm

P-LAM

**HPL side panels****Pannelli in HPL****Panneaux en HPL****Seitliche HPL-Platten**

PVC-PSE

**Waste bag holder, powder coated**

Upper liftable holder  
Stable, black plastic lid with Caddie logo  
Lower, full steel base, dimension 354x566 mm LxW  
2 buckets, 12 Ltr. each (red and blue)

**Kit sacco spazzatura**

Supporto superiore ribaltabile  
Coperchio nero in plastica con logo Caddie  
Supporto inferiore in acciaio, ribaltabile  
2 secchi da 12 Ltr. (uno rosso e uno blu)

**Support sac à déchets**

Support supérieur relevable  
Couvercle noir en plastique avec logo Caddie  
Support seaux relevable en acier dim. 354x566 mm LxW  
2 seaux de 12 Ltr. (rouge et bleu)

**Müllsackhalterung, pulverbeschichtet**

Obere, hoch klappbare Halterung  
Stabiler, schwarzer Kunststoff-Deckel mit Caddie Logo  
Untere Ablage aus Metall  
2 Eimer à 12 Ltr. (Rot und Blau)

PVC/SAC

**Holders for waste sorting kit with 1 bag and mask bag**

Upper liftable holder equipped for 1 bag  
Stable, black plastic lid with Caddie logo  
Suspension stirrup made of metal with 1 rubber bands for fixing the waste bag  
Grey laundry bag (127 Ltr.) used as mask bag

**Kit 1 sacco spazzatura con sacco maschera**

Supporto superiore ribaltabile  
Coperchio nero in plastica con logo Caddie  
Sacco in poliestere grigio 127 Ltr. con chiusura a cordoncino  
Supporto inferiore ribaltabile con barre in metallo e ruote paracolpo antitraccia Ø100 mm

**Support sac à déchets pour tri à 1 sacs avec sac de cache**

Support supérieur relevable  
Couvercle noir en plastique avec logo Caddie  
Support inférieur relevable avec barres anti-affaissement et 2 pare-chocs annulaires d'angle non marquant Ø 100 mm  
Sac à linge gris 127 Ltr.

**1 geteilte Müllsackhalterung, mit Sichtschuttsack**

Obere, hoch klappbare Halterung  
Stabiler, schwarzer Kunststoff-Deckel mit Caddie Logo  
Anthrazit Polyester-Wäschesack mit Kordelzug, 127 Ltr.  
Untere, hoch klappbare Ablage mit Metallstreben und nicht abfärbende Abweisrollen Ø 100 mm

PVC2

**Waste bag holder for 2 bags, powder coated for Tahiti and Palacenet**

Upper liftable holder  
Stable, black plastic lid with Caddie logo  
Suspension stirrup made of metal with 2 rubber bands for fixing of the waste bags  
Bumpers Ø100 mm

**Kit 2 sacchi spazzatura per Tahiti e Palacenet**

Supporto superiore ribaltabile  
Coperchio nero in plastica con logo Caddie  
Supporto inferiore ribaltabile con barre in metallo e ruote paracolpo antitraccia Ø100 mm

**Support sac à déchets pour tri à 2 sacs pour Tahiti et Palacenet**

Support supérieur relevable intégrant 2 anneaux de fixation ayant chacun un élastique pour maintenir un sac.  
Couvercle noir en plastique avec logo Caddie  
Support inférieur relevable avec barres anti-affaissement et 2 pare-chocs annulaires d'angle non marquant Ø100 mm

**2 geteilte Müllsackhalterung, pulverbeschichtet für Tahiti und Palacenet**

Obere, hoch klappbare Halterung  
Stabiler, schwarzer Kunststoff-Deckel mit Caddie Logo  
Untere, hoch klappbare Ablage mit Metallstreben und nicht abfärbende Abweisrollen Ø 100 mm

PVC2/SAC

**Holders for waste sorting kit with 2 bags and mask bag for Tahiti and Palacenet**

Upper liftable holder equipped for 2 bags  
Stable, black plastic lid with Caddie logo  
Suspension stirrup made of metal with 2 rubber bands for fixing the waste bags  
Grey laundry bag (127 Ltr.) used as mask bag

**Kit 2 sacchi spazzatura con sacco maschera per Tahiti e Palacenet**

Supporto superiore ribaltabile  
Coperchio nero in plastica con logo Caddie  
Sacco in poliestere grigio 127 Ltr.  
Supporto inferiore ribaltabile con barre in metallo e ruote paracolpo antitraccia Ø100 mm

**Support sac à déchets pour tri à 2 sacs avec sac de cache pur Tahiti et Palacenet**

Support supérieur relevable prévue pour le maintien de 2 sacs grâce à 2 élastiques (fournis)  
Couvercle noir en plastique avec logo Caddie  
Support inférieur relevable avec barres anti-affaissement et 2 pare-chocs annulaires d'angle non marquant Ø100 mm  
Sac à linge polyester avec cordelette, 127 Ltr.

**2 geteilte Müllsackhalterung, mit Sichtschuttsack für Tahiti und Palacenet**

Obere, hoch klappbare Halterung  
Stabiler, schwarzer Kunststoff-Deckel mit Caddie Logo  
Anthrazit Polyester-Wäschesack mit Kordelzug, 127 Ltr.  
Untere, hoch klappbare Ablage mit Metallstreben und nicht abfärbende Abweisrollen Ø 100 mm

PP/F

**Cutlery tray with 1 drawer with 6 compartments closed by a small door****Pratico cassetto porta posate a 6 scomparti****Range-couverts pratique à 6 compartiments****Sechs Fächer zur Einteilung von Besteck**



# OPTIONS | OPTIONEN

RF



Upgrade for 2 wheels with brake

Supplemento per 2 ruote con freno

Option 2 roulettes fixes et 2 roulettes pivotantes à frein.

Aufpreis für 2 Bremsrollen

RG



Upgrade for 4 superelastic swivel wheels, 2 with brake, it is not possible to mount the option RS5 with RG

Supplemento per 4 ruote super elastiche Ø200 mm di cui due con freno, optional non compatibile con RS5

Option 4 roues superelastiques pivotantes Ø200 mm dont 2 à frein.

4 Soft-Lenkrollen Ø200 mm, davon 2 Bremsrollen Montage der Option RS5 nicht möglich

RGI



Upgrade for 4 swivel wheels Ø200 mm without brakes

Supplemento per 4 ruote super elastiche Ø200 mm girevoli

Option 4 roues pivotantes Ø200 mm sans frein

Aufpreis für 4 Soft-Lenkrollen Ø200 mm

RGB



Upgrade for 4 superelastic wheels Ø200 mm: 2 swivel with brake, 2 fixed wheels

It is not possible to mount the option RS5 with RGB  
Supplemento per 4 ruote super elastiche Ø200 mm di cui due fisse e due con freno

Optional non compatibile con RS5

Option 4 roues Ø200mm superelastiques : 2 pivotantes avec frein, 2 fixes

Avec RGB ce n'est pas possible de monter l'option RS5

Aufpreis für 2 Soft Lenk- und 2 Bockrollen Ø200 mm, davon 2 Bremsrollen

Montage der Option RS5 nicht möglich

RNY



Upgrade for 4 nylon swivel wheels, 2 with brake

Ideal for carpeted floors  
Wheel made of nylon Ø160 mm

Supplemento per 4 ruote Nylon di cui 2 con freno

Ideali per moquette  
Ruota in nylon Ø160 mm

Option 4 roulettes nylon pivotantes dont 2 à frein

Pour sol en moquette souple  
Roulette avec bandage dur nylon Ø160 mm

Aufpreis für 4 Nylon-Lenkrollen, davon 2 Bremsrollen

Geeignet für tiefe, hochflorige Teppichböden  
Rolle aus Nylon Ø160 mm

RNYI



Upgrade for 4 nylon swivel wheels, without brake

Ideal for carpeted floors  
Wheel made of nylon Ø160 mm

Supplemento per 4 ruote Nylon girevoli

Ideali per moquette  
Ruota in nylon Ø160 mm

Option 4 roulettes nylon pivotantes sans frein

Pour sol en moquette souple  
Roulette avec bandage dur nylon Ø160 mm

Aufpreis für 4 Nylon-Lenkrollen

Geeignet für tiefe, hochflorige Teppichböden  
Rolle aus Nylon Ø160 mm

RNYB



Upgrade for 4 nylon wheels, and 2 fixed, 2 swivel with brake

Ideal for carpeted floors  
Wheel made of nylon Ø160 mm

Supplemento per 4 ruote in Nylon di cui 2 fisse e 2 girevoli con freno

Ideali per moquette  
Ruota in nylon Ø160 mm

Option 4 roulettes nylon dont 2 fixes, 2 pivotantes avec frein

Pour sol en moquette profonde  
Roulette avec bandage dur nylon Ø160 mm

Aufpreis für 4 Nylon-Lenk-Blockrollen, davon 2 Bremsrollen

Geeignet für tiefe, hochflorige Teppichböden  
Rolle aus Nylon Ø160 mm

RS



Upgrade for 4 nylon wheels, and 2 fixed, 2 swivel

4 wheels (2 fixed and 2 swivel castors).  
Sturdy and silent Nylon wheels.  
Big 110 mm rear wheels, small 50 mm front wheels.

Supplemento per 4 ruote in nylon di cui 2 fisse e 2 girevoli

4 ruote (2 ruote fisse e 2 ruote girevoli).  
Ruote in Nylon robuste e silenziose. Grandi ruote posteriori da 110 mm, piccole ruote anteriori da 50 mm

Option 4 roulettes nylon dont 2 fixes, 2 pivotantes

4 roues en nylon. Roues arrière Ø 100 mm, et roues avant Ø 50mm.

Aufpreis für 4 Nylon-Lenk-Blockrollen

Robuste und leise Nylonrollen mit Doppelkugellagern  
Hinterrad Ø 100 mm, Bockrollen  
Vorderrad Ø50 mm, Lenkrollen

# OPTIONS | OPTIONALS



RS5

**Additional fifth wheel (only for trolley size M and L), Ø100 mm**  
 Centrally mounted for more stability and an improved handling when fully loaded  
 Rubber tread  
**Quinta ruota centrale (solo per modelli M e L) Ø100 mm**  
 Montata al centro del carrello, maggiore stabilità e gestione anche a pieno carico  
 Rivestimento in gomma

**5ème roue centrale additionnelle (seulement sur chariot taille M et L) Ø100 mm**  
 Montage central pour plus de stabilité et une maniabilité améliorée en charge  
 Bandage caoutchouc  
**Fünfte, zusätzliche Rolle (nur für M & L Maßen), Ø100 mm**  
 Mittig montiert für zusätzliche Stabilität und leichtere Manövrierbarkeit Gummilauffläche im beladenen Zustand



RJ

**Upgrade for 4 swivel wheels Ø100 mm, 2 with brakes**  
**Supplemento per 4 ruote super elastiche Ø100 mm girevoli, di cui 2 con freno**

**Option 4 roues pivotantes Ø100 mm dont 2 à frein**  
**Aufpreis für 4 Soft-Lenkrollen Ø100mm, davon 2 Bremsrollen**

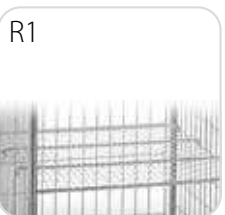

R1

**Removable shelf for roll container, electrolytically galvanized**  
 Dimensions LxW in mm: 625x724, unit weight: 3,5 kg  
 Mesh dimensions: 60x130 mm  
**Ripiano amovibile per roll container in filo d'acciaio zincato**  
 Dimensioni LxW 625x724, peso 3,5 kg  
 Dimensione della maglia 60x130 mm

**Etagère amovible pour container roll en fil d'acier soudé et électro-galvanisé**  
 Dimensions LxL en mm: 625x724, poids : 3,5 kg  
 Dimensions des mailles en mm: 60x130  
**Elektrolytisch verzinktes Einlegegitter**  
 Maße LxB mm: 625x724, Gewicht: 3,5 kg  
 Maschenweite 60x130



R1 ROLLBAG

**Removable shelf for ROLLBAG**  
**Ripiano amovibile per ROLLBAG**

**Etagère amovible pour ROLLBAG**  
**Einlegegitter für ROLLBAG**



SAC

**Laundry bag holder, powder coated**  
 Upper liftable holder  
 Lower liftable base with metal bars and abrasion-proof, non-marking donut bumpers Ø 100 mm  
 Polyester laundry bag with drawstring (127 Ltr.)  
**Kit sacco biancheria poliestere**  
 Supporto superiore ribaltabile  
 Supporto inferiore ribaltabile con barre in metallo e ruote paracolpo antitraccia Ø100 mm  
 Sacco biancheria in poliestere grigio con chiusura a cordoncino (127 Ltr.)

**Support Sac à linge**  
 Support supérieur relevable  
 Support inférieur relevable avec barres anti-affaissement et 2 pare-chocs annulaires d'angle non marquant Ø100 mm  
 Sac à linge polyester avec cordelette, 127 Ltr.  
**Wäschesackhalterung, pulverbeschichtet**  
 Obere, hoch aklappbare Halterung  
 Untere, hoch klappbare Ablage mit Metallstreben und nicht abfärbende Abweisrollen Ø 100 mm  
 Anthrazit Polyester-Wäschesack mit Kordelzug, 127 Ltr.



SAC-B

**Laundry bag, powder coated**  
 Polyester laundry bag with drawstring (50 Ltr.)  
**Kit sacco biancheria poliestere**  
 Sacco biancheria in poliestere grigio con chiusura a cordoncino (50 Ltr.)

**Sac à linge**  
 Sac à linge polyester avec cordelette, 50 Ltr.  
**Wäschesack**  
 Anthrazit Polyester-Wäschesack mit Kordelzug, 50 Ltr.



SATELLITE

**Removable trolley with waste bag and cover, used either alone or connected to the BALI trolley**  
 Steel tube frame  
 Clip-on system for BALI  
 2 fixed castors  
**Carrello rimovibile con sacco per rifiuti e coperchio, usato da solo o collegato al carrello BALI**  
 Telaio in tubo d'acciaio  
 Sistema a clip per BALI  
 2 ruote fisse

**Chariot détachable avec sac poubelle et couvercle, utilisé seul ou connecté au chariot BALI**  
 Cadre en tube d'acier  
 Système à clipser pour BALI  
 2 roulettes fixes  
**Abnehmbarer Müll- oder Wäschewagen mit Sichtschutz, einzeln verwendbar oder verbunden mit BALI**  
 Stahlrohrrahmen  
 Andocksystem für BALI  
 2 Bockrollen



SE

**SE-Bucket of 12 L.**  
 2 buckets, 12 Ltr. each (red and blue)  
**Secchio SE da 12 L.**  
 2 secchi da 12 Ltr. ciascuno (rosso e blu)

**SE-Seau de 12L.**  
 2 seaux de 12 Ltr. (rouge et bleu)  
**Eimer Kunststoff**  
 2 Eimer à 12 Ltr. (rot und blau)

# OPTIONS | OPTIONEN



**SUPP**  
Metallic Support for fix the Display on post  
**SUPP**  
Supporto metallico per il fissaggio del Display sulla colonnina

**SUPP**  
Support métallique pour fixer Display sur le poteau  
**SUPP**  
Metallic Support zur Befestigung des Displays am Pfosten



Protection frame for ALTO 2 and ALTO ICE 3  
Spondine cromate per ALTO 2 e ALTO ICE 3

Cadre de protection pour ALTO 2 et ALTO ICE 3  
Schutzreling für ALTO 2 und ALTO ICE 3



Lower protection frame for ARTE 2 and ARTE BM1  
Spondine inferiori cromate per ARTE 2 e ARTE BM1

Cadre de protection pour étagère inférieure de ARTE 2 et ARTE BM1  
Verchromte untere Schutzreling für ARTE 2 und ARTE BM1



**Compartment pocket, grey**  
2 bigger pockets (approx. 22\*21cm)  
2\*3 middle size, transparent pockets (approx. 14\*21cm)  
Fixation to the upper holder by velcro loops and additional velcro strips on rear  
**Tasca a 8 scompartimenti**  
2 ampie tasche (circa 22x21 cm)  
6 tasche trasparenti di medie dimensioni (circa 14x21 cm) disposte su due livelli  
Fissata al carrello tramite velcro

**Sac gris 8 compartiments**  
2 grandes poches (approx. 22\*21cm)  
2 niveaux de 3 poches transparentes (approx. 14x21cm)  
Fixation latérale sur chariot avec vélcro  
**Kleinartikel-Tasche aus Kunststoff, grau**  
2 größere Kunststofffächer (ca. 22x21cm)  
2 x 3 mittlere, transparente Taschen (ca. 14x21cm)  
Befestigung mittels Klettverschluss-Schleufe an oberer Halterung sowie Klettverschluss-Streifen auf Rückseite



**Tool box**  
Handly tool box with grip  
Material: Polypropylene copolymer  
Dimensions: Height (with handle) 26 cm, Width 29 cm, Length 33 cm; Single drawers 10x30x14 cm  
**Tool box**  
Cassetta multiscoperto con impugnatura  
Materiale: copolimero di polipropilene  
Misure: altezza (con manico) 26 cm, larghezza 29 cm, lunghezza 33 cm; Cassetti singoli 10x30x14 cm

**Boîte à rangement**  
Boîte à outils manuelle avec poignée  
Matériau: Copolymère de polypropylène  
Mesures: Hauteur (avec poignée) 26 cm, Largeur 29 cm, longueur 33 cm; Compartements simples 10x30x14 cm  
**Flaschen- und Mehrzweckkasten**  
Handlicher Behälter mit Griff  
Material: Polypropylen-Copolymer  
Maße: Höhe (mit Griff) 26 cm, Breite 29 cm, Länge 33 cm  
Einzelfach 10x30x14 cm



New pedal-twin-brake system, activating 2 brakes at once  
Nuovo sistema di freno a pedale che permette di bloccare due ruote contemporaneamente

Nouveau système »twin brake« permettant d'activer 2 freins en même temps avec une pédale  
Pedal-Twin-Bremssystem, aktiviert 2 Bremsen gleichzeitig



**UK plug**  
UK format plug  
**Preso UK**  
Preso formato Britannico

**Prise britannique**  
Prise format GB  
**UK-Stecker**  
UK-Format Stecker



**Vacuum clip**  
One vacuum clip, possibility to add more clips  
**Clip per aspirapolvere**  
Clip per scopa, possibilità di aggiungere altre

**Clip aspirateur**  
Possibilité d'en ajouter plusieurs  
**Besenclip**  
Kunststoff Besenhalter

VH



**Vacuum cleaner holder, powder coated**  
Lower liftable, full steel base with retaining bar  
Donut bumpers on each corner Ø100 mm  
Upper holder 340 L x 370 D

**Kit porta aspirapolvere**

Supporto inferiore con barre in metallo  
Ruote paracolpo antitraccia Ø100mm  
Supporto inferiore 340 L x 370 D

**Support aspirateur**

Support inférieur relevable  
Pare-chocs annulaires d'angle Ø100 mm  
Support supérieur 340 L x 370 P

**Staubsaugerhalterung, pulverbeschichtet**

Untere, hoch klappbare Ablage aus Metall  
und nicht abfärbende Abweisrollen Ø100 mm  
Oberer, hoch klappbarer Haltebügel 340 L x 370 D

000LID

**Lid**

Hardtop lid for Handie  
**Chiusura superiore rigida**  
Chiusura superiore rigida per Handie

**Couvercle rigide**

Couvercle rigide pour Handie  
**Verstärkte Abdeckung für Handie**

0000ARC

**Parking bay row + chain**

Arc for parking luggage trolley in galvanized steel tube. Inc. 400 mm start chain + key. Does not include bottom stop

**Arco aprifila con catena**

Arco di inizio fila per carrelli in tubo di acciaio zincato.  
Con catena lunga 400 mm con gancio di fissaggio per carrelli.

**Arceau de départ + chaîne de départ**

Arceau départ 1 file pour chariot bagages. Tube d'acier galvanisé. Inc. chaîne de départ 400 mm+clé. Arrêt au fond non inclus

**Reihenanfängsbügel + Kette**

Bügel zum Abstellen des Gepäckwagens aus verzinktem Stahlrohr. Inkl. 400 mm Startkette + Schlüssel. Beinhaltet keinen unteren Anschlag.

SC-120

**Starting Chain**

Starting chain stainless steel 1200 mm with wall fixation

**Catena**

Catena con fissaggio a muro da 1200 mm per ritito carrello

**Chaîne de départ**

Chaîne de départ murale 1200 mm

**Starterkette**

Startkette Edelstahl 1200 mm + Schlüssel mit Wandfixierung

99013697

**Neutral plate**

Neutral plate 40\*20 cm for Equinox 27 trolley.

**Placca per pubblicità**

Placca per pubblicità di 40x 20 cm per Equinox 27.

**Plaque neutre**

Plaque neutre 40\*20 cm pour chariot Equinox 27.

**Neutrale Werbeplatte**

Werbeplatte Maße 40x 20 cm für Equinox 27.

# PANEL FINISH | FINITURE



**HPL**  
High pressure laminate  
Pannelli in HPL

Panneaux HPL /laminé haute pression  
Hochdruck Schichtholzplatten



**SFB**  
Fabric  
Tessuto  
Tissu  
Stoff-Optik

**SOM**  
Elm  
Olmo  
Orme  
Ulme

**SWE**  
Wenge  
Wenge  
Wenge  
Wenge

**SNE**  
Cliff  
Scogliera  
Falaise  
Fels-Optik



**LAM**  
Laminated wood structure  
Pannelli in legno laminato

Panneaux bois mélaminés  
Melaminharzbeschichtetes Holz



**LNO**  
Walnut  
Noce  
Noyer  
Nussbaum

**LWE**  
Wenge  
Wenge  
Wenge  
Wenge

**LAN**  
Anthracite  
Antracite  
Anthracite  
Anthrazit

**LNE**  
Fog  
Nebbia  
Brouillard  
Nebel

**LNV**  
Veined black  
Nero venato  
Noir Veiné  
Schwarz

**LBE**  
Birch  
Betulla  
Bouleau  
Birke



**LWS**  
White sand  
Sabbia bianca  
Sable blanc  
Weißer Sand

**LOM**  
Elm  
Olmo  
Orme  
Ulme

**LBV**  
Veined white  
Bianco venato  
Blanc veiné  
Weiß

**LTR**  
Travertine  
Travertino  
Travertin  
Travertin

**LCO**  
Corten  
Corten  
Corten  
Cortenstahl

# PANEL FINISH | FINITURE



**SWS**

Solid wood structure  
Pannelli in legno massello

Panneaux bois massif  
Massivholz



**NEW**

**MNO**  
Walnut  
Noce  
Noyer  
Nussbaum



**NEW**

**MGR**  
Veined grey  
Grigio venato  
Gris veiné  
Grau marmoriert



**NEW**

**MWE**  
Wenge  
Wenge  
Wenge  
Wenge



**NEW**

**RAL**



**Passepartout**

Laminated wood structure  
Pannelli in legno laminato

Panneaux bois mélaminés  
Melaminharzbeschichtetes Holz

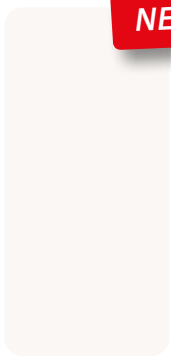

**NEW**

**PWH \***  
White  
Bianco  
Blanc  
Weiß

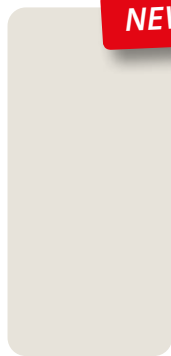

**NEW**

**PLG \***  
Light grey  
Grigio chiaro  
Gris clair  
Lichtgrau



**NEW**

**PMB**  
Metal Black  
Nero Metallico  
Noir métallique  
Metallschwarz



**NEW**

**PBE**  
Beech  
Faggio  
Hêtre  
Buche



**NEW**

**PCW \***  
Cherry wood  
Ciliegio  
Cerisier  
Kirschbaum



**NEW**

**PNO \***  
Walnut  
Noce  
Noyer  
Nussbaum



**NEW**

**PMA \***  
Mahogany  
Mogano  
Acajou  
Mahagoni



**NEW**

**PWE**  
Wenge  
Wenge  
Wenge  
Wenge



**NEW**

**PDO \***  
Dark oak  
Rovere moro  
Chêne foncé  
Mooreiche

\* Colors available on request starting from a minimum of order of 10 pieces.

\* Colori disponibili su richiesta a partire da 10 pezzi MOQ.

\* De nombreux coloris sont disponibles à partir de 10 pièces.

\* Weitere Farben sind bereits ab einer Mindestbestellmenge von 10 Stück auf Anfrage erhältlich.

# FINITIONS | AUSFÜHRUNGEN

## Buddie / Buddie Bar



BK  
Black  
Nero  
Noir  
Schwarz



BR  
Brown  
Marrone  
Marron  
Braun



BL  
Blue  
Blu  
Bleu  
Blau



RE  
Red  
Rosso  
Rouge  
Rot



RAL  
Many other colors available on request starting from a minimum of order of 15 pieces.  
Molti altri colori sono disponibili su richiesta a partire da 15 pezzi MOQ.  
De nombreux autres coloris sont disponibles à partir de 15 pièces.  
Weitere Farben sind bereits ab einer Mindestbestellmenge von nur 15 Stück auf Anfrage erhältlich.

## Moquette



Black  
Nero  
Noir  
Schwarz



Grey  
Grigio  
Gris  
Grau



Blue  
Blu  
Bleu  
Blau



Red  
Rosso  
Rouge  
Rot

Different shade of colour between polyamide and polypropylene carpets  
Sfumature di colore differenti tra le moquette in polipropilene e poliammide  
Nuances de couleur différentes entre la moquette en polyamide et polypropylène  
Unterschiedlicher Farbton zwischen Polyamid- und Polypropylenteppichen









Hospitality Excellence since 1928

The images reproduced in this catalogue are indicative. The manufacturer reserves the right to make technical, aesthetic and dimensional changes on the materials and models presented without prior notice. Weights, Dimensions, etc. are simply provided as an indication and do not bind the manufacturer. All the aforementioned differences are not such as to significantly modify the products themselves and do not constitute a reason for returning or replacing the goods or contesting variations in the volume of shipments.

Finally, the following edition replaces each previous edition.

Le foto riprodotte in questo catalogo sono indicative per le inevitabili differenze dovute alla riproduzione tipografica. Il costruttore si riserva il diritto di apportare modifiche tecniche, estetiche e dimensionali e su i materiali e modelli presentati senza preavviso. I pesi, le misure, ecc., sono semplicemente forniti a titolo indicativo e non impegnano il costruttore. Tutte le differenze sopraindicate non sono tali da modificare significativamente i prodotti stessi e non costituiscono motivo di reso o sostituzione della merce o di contestazione per variazioni nel volume delle spedizioni.

Infine la seguente edizione va a sostituire ogni edizione antecedente.

Les photos reproduites dans ce catalogue sont indicatives des différences inévitables dues à la reproduction typographique. Le fabricant se réserve le droit d'apporter des modifications techniques, esthétiques et dimensionnelles ainsi que sur les matériaux et modèles présentés sans préavis. Les poids, mesures, etc. sont simplement fournis à titre indicatif et ne lient pas le fabricant. Toutes les différences mentionnées ne modifient pas de manière significative les produits eux-mêmes et ne constituent pas un motif de retour ou de remplacement des marchandises ou de contestation pour variation du volume des expéditions. Enfin, l'édition présente remplace chaque édition précédente.

Die in diesem Katalog wiedergegebenen Fotos sind indikativ wegen der Unterschiede aufgrund typografischer Reproduktion. Der Hersteller behält sich das Recht vor, technische, ästhetische und maßliche Änderungen an den vorgestellten Materialien und Modellen ohne vorherige Ankündigung vorzunehmen. Gewichte, Maße usw. dienen lediglich als Anhaltspunkt und sind für den Hersteller nicht verbindlich. Alle oben genannten Unterschiede bewirken keine wesentlichen Änderungen der Produkte selbst und sind kein Grund für die Rücksendung oder den Umtausch der Waren oder für beanstandete Abweichungen im Sendungsvolumen. Schließlich ersetzt die folgende Ausgabe jede vorherige Ausgabe.



**Caddie Hotel Srl**  
**International Headquarter**

Via della Costiera 6/8  
IT-20010 Buscate  
Italy

Via Industria 33/35  
IT-20080 Albairate  
Italy

T: +39 02 94 06 578  
info@caddie-hotel.com

**Caddie Hotel GmbH**

Albertstr. 2-6  
D-73054 Eislingen  
Germany

T: +49 (0)71 61 98 81 255  
F: +49 (0)71 61 98 30 946  
info@caddie-hotel.de  
www.caddie-hotel.de

Printing and typesetting errors reserved. The printed colors of products in this catalogue may have a limited deviation from the physical product. Product images may show options as well as decoration. Finally, the following edition replaces each previous edition.  
Potrebbero essere presenti errori di battitura e stampa. Le dimensioni sono approssimative ed i colori possono essere differenti rispetto agli originali. I prodotti potrebbero subire variazioni senza preavviso. Le immagini potrebbero includere optional e finiture non incluse nel prezzo base. L'edizione corrente sostituisce ogni edizione precedente.  
Erreurs d'impression ne peuvent être exclues. Toutes dimensions à considérer comme approchantes, Coloris peuvent varier. Toute modification technique ou de conception réservée. Les images peuvent présenter des équipements dotés d'accessoires et de finitions optionnels.  
Irrtümer, Druck- und Satzfehler vorbehalten. Maßangaben annähernd, Farben können abweichen. Konstruktive Fehler und Änderungen vorbehalten. Abbildungen können Sonderausstattungen / Dekore enthalten.

V.1.1 © Caddie Hotel Srl 2021

[www.caddie-hotel.com](http://www.caddie-hotel.com)



Hospitality Excellence since 1928